



PRODUCT
CATALOG

2022

Contents

About	4
What's new?	14
Ethernet routers	14
Switches	16
60 GHz products	17
LTE/5G products	18
IoT products	19
Accessories	19
LTE/5G products	20
GPEN Concept	22
IoT products	24
Premium class home access points	28
PWR-Line Series	29
Ethernet routers	30
hEX series	32
PowerBox series	33
RB2011 series	34
Cloud Core Router series	37
Switches	41
SOHO switches	41
Medium business switches	43
Enterprise switches	47
Outdoor wireless systems	50
2.4 GHz integrated directionals	50
2.4 GHz integrated base stations	51
5 GHz integrated directionals	52
5 GHz integrated base stations	56
Connectorized units	58
60 GHz integrated units	60
6 GHz integrated units	62
Wireless for home and offices	63
Single band 2.4 GHz access points	63
Dual band home access points	66
Devices with LTE support	70
RouterBOARD	72
Devices with one Ethernet port	72
Devices with multiple Ethernet ports	74
Accessories	74
Accessories for LTE	75
Accessories for fiber	77
Power supplies	81
Antennas and antenna accessories	83
Other accessories	86

Why MikroTik?

MikroTik provides routing, switching and wireless equipment for all possible uses - from the customer location, up to high end data centres.

We have an extensive network of trained consultants, training centres and distributors in almost every country of the world.

Established in Europe in 1996, we have 26 years of experience in networking and wireless installations.

Our in-house developed RouterOS software supports most common and many special features and we are constantly adding new customer requested features.

Whether you are building wireless links across the seas, internet exchanges between countries or secure tunnels between banks- MikroTik can do it all.

- Best price/performance
- Millions of RouterOS powered devices are currently routing the world
- 26 years of developing networking software and hardware
- Over 200'000 RouterOS trained and certified network engineers
- Several thousand training sessions conducted each year
- World wide network of certified consultants
- Offering products that support simple CPEs to complex enterprise networks
- Thousands of pages of documentation, examples, application notes, and guides



MikroTik

We are a security and innovation focused European router software and hardware manufacturer, that offers the most flexible and user friendly, up to carrier-class routing and network management solutions. Our products are used by ISPs, individual users and companies for building data network infrastructures all around the world – even in space research, ocean research and on Mount Everest.

There are millions of installations worldwide going back as far as 1996!

Our mission is to make existing Internet technologies faster, more powerful, adaptable and affordable to wider range of users. That is why we offer enterprise-level solutions with consumer-grade pricing.



RouterOS

MikroTik RouterOS is the operating system of MikroTik RouterBOARD hardware.

It has all the necessary features for an ISP- routing, firewall, bandwidth management, wireless access point, backhaul link, hotspot gateway, VPN server and more.

RouterOS is a stand-alone operating system based on the Linux kernel, and our goal here at MikroTik is to provide all these features with a quick and simple installation and an easy to use interface.

- Powerful QoS control
- RIP, OSPF, BGP, MPLS routing
- Bonding of interfaces
- Stateful firewall, tunnels
- (R)STP bridging with filtering
- High speed 802.11a/b/g/n/ac
- 60 GHz wireless
- Wireless TDMA (Nv2)
- WDS and Virtual AP
- HotSpot Plug-and-Play access
- WinBox GUI and Web admin
- Telnet/MAC-Telnet/SSH/Console
- Real-time configuration and monitoring
- IPsec hardware acceleration
- 2G, 3G, 4G (LTE) and 5G support

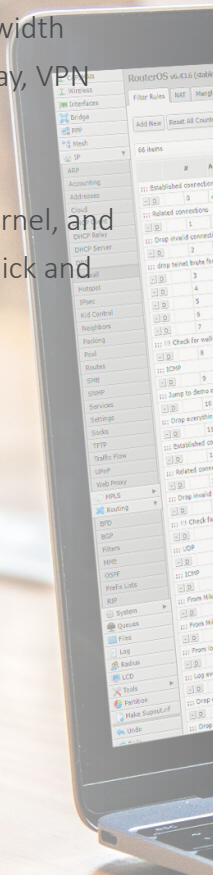



Filter	Chain	Src. Address	Dst. Address	Prot.	Src. Port	Dst. Port	Any. Port	In. Interf.	Dst. Interf.	Bytes	Packets
										197.4 MB	15 103 213
	input									565.2 KiB	2 871
	input									1155.7 KiB	24 495
	input									0.0 B	0
drop	input									0.0 B	0
conn				6 (Drop)		33				0.0 B	0
drop	input			6 (Drop)		33				0.0 B	0
add src fi	input			6 (Drop)		33				0.0 B	0
add src fi	input			6 (Drop)		33				0.0 B	0
add src fi	input			6 (Drop)		33				0.0 B	0
known viruses	input									28.8 MB	524 461
	input									6.8 MB	74 824
jump	input			1 Comp						24.0 MB	420 857
accept	input									1489.0 KiB	10 528
jump	input									0.0 B	0
drop	input									0.0 B	0
drop	input									0.0 B	0
accept	forward									0.0 B	0
accept	forward									0.0 B	0
accept	forward									0.0 B	0
drop	forward									0.0 B	0
jump	forward									0.0 B	0
accept	forward									0.0 B	0
accept	forward									0.0 B	0
accept	customer	198.148.141.								0.0 B	0
accept	customer	198.148.172.								0.0 B	0
accept	customer	10.0.0.0/8								0.0 B	0
log	customer									0.0 B	0
drop	customer									0.0 B	0

MUM

MikroTik User Meeting (MUM) is a conference on MikroTik RouterOS software and RouterBOARD hardware. Meet master distributors and certified trainers, consultants and experienced network engineers. Find answers to your questions, watch presentations, talk with industry experts and witness latest technology demos by MikroTik and participants themselves – all here, at the MUM.

The MUM is also one of the largest and the most consistent WISP conferences in the world, constantly bringing more and more MikroTik users together. Maximum knowledge in the shortest possible time, as well as unique opportunities for new business and sales contacts – don't miss it!

The MUM has already taken place more than 200 times, in 80 countries across all the continents. MUM events keep breaking previous attendance records with more and more people coming every year. More than 3700 people attended the conference in Indonesia in 2018! You should come too!



Academy

Colleges, universities, and schools around the world are starting MikroTik Academy programs to offer students Internet networking courses using MikroTik RouterOS as a learning tool. We are actively enrolling new locations weekly and looking for new applicants.

There are no charges from MikroTik for material, online testing, and online certificates associated with this program. MikroTik Academy program offers schools an excellent networking education program and program materials for little or no cost.

The program courses offer:

- a proven network education program
- official MikroTik RouterOS certification exams
- discounted (and free) hardware and free RouterOS licenses for training classes

If there is an educational institution near you that could be interested in the MikroTik Academy program, please contact us or forward this information to them.

Please contact us at training@mikrotik.com.

Official MikroTik Academy Web Page:
mikrotikacademy.com

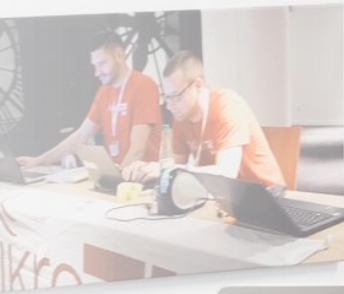
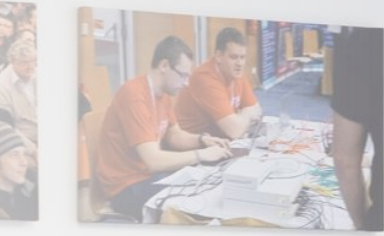

CCR2216-1G-12XS-2XO

Unleash the power of 100 Gigabit networking with L3 Hardware Offloading!

- Millions of packets per second with L3HW Offloading!
- Powerful Amazon Annapurna Labs ARMv8 16-core CPU
- Marvell Prestera® Aldrin2 DX8525
- Gigabit Ethernet
- 12x 25 Gigabit SFP28
- 2x 100 Gigabit QSFP28
- Dual-redundant hot-swap 150W PSU's
- 16 GB RAM
- 2x M.2 SATA
- Lower power consumption than the previous flagship.

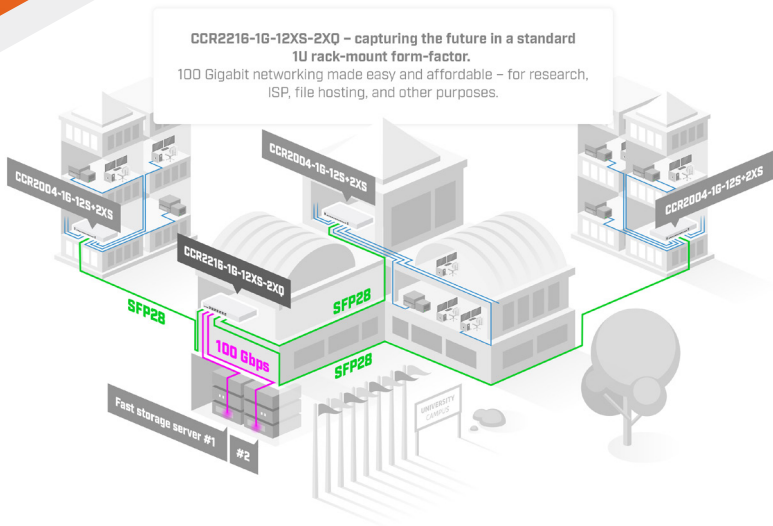



CCR2116-12G-4S+

mt.lv/p/558 



10G networking meets the unparalleled power of a modern ARM CPU. The most powerful CCR ever.

- 16-core, 2 GHz ARM CPU
- 16 GB DDR4 RAM
- 128 MB NAND
- Gigabit Ethernet
- 10G SFP+
- USB 3.0
- Dual-redundant power supply

CCR2004-1G-2XS-PCIE

mt.lv/p/563 

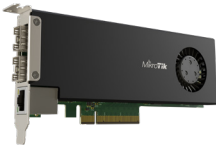

The smart and easy way to create 25 Gigabit networks if you want to save space in your server room.

- All RouterOS features
- Quad-core ARMv8 CPU
- Fully functional CCR2004 in PCIe 3.0 x8 form-factor
- 2x SFP28 cages for 25 Gigabit networking
- Gigabit Ethernet
- 4GB DDR4 RAM
- Low-profile format – fits in 2U server chassis
- Powered by the server motherboard

CCR2004-16G-2S+PC

mt.lv/p/571 



Up to 300% faster than the previous CCR1009 routers- in a blissful silence!

- 16x Gigabit Ethernet ports
- 2x 10G SFP+ cages
- Powerful quad-core CPU
- RJ-45 console port

CRS504-4XQ-IN

Your most affordable, compact, energy-efficient doorway to the world of 100 Gigabit networking. The next step in upgrading existing 10 or 25 Gigabit networks.

- 16x25 Gigabit Marvell Prestera switch chip
- Multiple powering options: PoE-in, DC jack, 2-pin terminal
- Dual hot-swap power supplies
- 4x 100 Gigabit QSFP28 ports
- Compatible with 40G, 25G, 10G, and 1G fiber connections
- Uses 25W of power

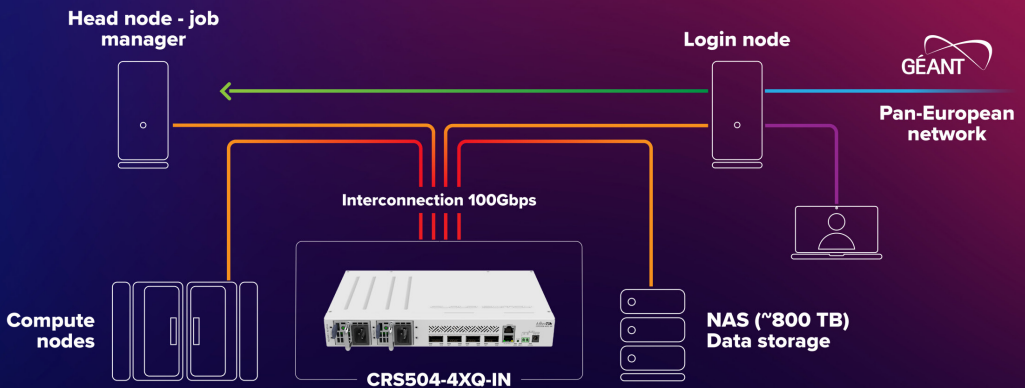

CRS310-1G-5S-4S+IN

mt.lv/p/567 



10 Gigabit fiber connectivity way over a 100 meters – for small offices or ISPs. Hardware offloaded VLAN-filtering and even some L3 routing on a budget!

- Gigabit Ethernet
- SFP
- 10 Gigabit SFP+
- PoE-in
- 100-120% faster than the CRS212

60 GHz products

CubeSA 60Pro ac

mt.lv/p/566 



Enjoy a smooth 60 GHz experience with Cube 60Pro ac and CubeSA 60Pro ac!

- Gigabit Ethernet
- Powerful quad-core CPU
- 5 GHz failover
- Reach greater distance than ever with channel 5 support
- TDMA GPS sync
- Improved design and mounting options
- 60 GHz 802.11ay, compatible with previous 802.11ad products

Cube 60Pro ac

mt.lv/p/565 



Enjoy a smooth 60 GHz experience with Cube 60Pro ac and CubeSA 60Pro ac!

- Gigabit Ethernet
- Powerful quad-core CPU
- 5 GHz failover
- Reach greater distance than ever with channel 5 support
- TDMA GPS sync
- Improved design and mounting options
- 60 GHz 802.11ay, compatible with previous 802.11ad products

Wireless Wire Cube Pro

mt.lv/p/564 



A 2 Gb/s 60 GHz aggregate link with a 5 GHz failover. Forget about wires or downtime! Best price/performance on the market, stealthy and sturdy design.

- Reach distance up to 800m
- 60 GHz with automatic 5 GHz backup connection
- Compact and durable
- iOS/Android app for quick and easy configuration
- Gigabit Ethernet with PoE-in
- Powerful quad-core CPU

LHG LTE18 kit

mt.lv/p/569 

Great distances, even greater speed – with the power of the ultra fast LTE Category 18 modem. Last-mile-internet solution for the most remote areas.

- High-speed Internet even when your phone has no signal!
- Blazing fast CAT18 LTE modem
- Gigabit Ethernet with PoE-in
- Powerful 64-bit dual-core ARM CPU
- Large high-gain antenna
- Grid antenna design – perfect for harsh, windy weather





wAP LR2 kit

mt.lv/p/559 

Our newest out-of-the-box solution for LoRa® technology. Like the previous wAP LR kits, it contains a pre-installed UDP packet forwarder to any public or private LoRa® servers and an outdoor weatherproof wireless access point with 2.4 GHz WLAN interface and Ethernet port with PoE-in that could be used as a backend.



R11e-LR2

mt.lv/p/561 

A new Concentrator Gateway card for LoRa® technology in mini PCIe form – so you can create or customize your own 2.4 GHz IoT projects. It enables 2.4 GHz LoRa® connectivity for any MikroTik product that has a mini PCIe slot with connected USB lines. It supports 4 different RX channels and 1 TX channel.



TOF-2400-8V-4

mt.lv/p/560 

For extra network coverage (up to 3-4km in the line of sight), we suggest adding an external 8dBi Omni antenna - the TOF-2400-8V-4. If necessary, this antenna can be used for any 2.4 GHz device. Not only it works with the 2.4 GHz LoRa® connectivity, it also supports the regular 2.4 GHz WLAN. It comes with a 1m long SMA cable and a mechanical holder for quick and easy mast attachment – when you need that extra network coverage. Compact size and increased durability without sacrificing the power – this antenna will get the job done.

Accessories



MT-HotSwapFan

mt.lv/p/570 

Be prepared for the unexpected with the backup hot-swappable fans for our newest devices, such as the flagship CCR2216! If your fans go out of order at some point, you can swap them without unnecessary downtime, as there is no need to turn the router off.



QMP-LDF

mt.lv/p/572 

An advanced pole/mast mount adapter for our LDF series – for extra ease of use and versatility. There are two standard mounting options and additional QMP compatibility for mounting LDF on a wall. The adapter offers extra durability due to its unique plastic composite material – anvilNITE™.

Chateau 5G

mt.lv/p/537 

One router to delight them all – introducing the ultimate home AP with ultra-fast LTE/5G support.

- A high-speed, dual-band home access point with LTE/5G support – for really fast Internet anywhere, anytime
- 5 x Gigabit Ethernet ports
- Full-sized USB
- Comes with powerful external LTE/5G antennas for even stronger signal
- LTE Category- 20 (2.0 Gbps Downlink, 200 Mbps Uplink)
- 5G support- NSA (5.0 Gbps downlink, 650 Mbps uplink)SA (4.2 Gbps downlink, 900 Mbps uplink)
- Powerful quad-core CPU, 256 MB RAM



Intercell 10 B38+B39

mt.lv/p/506 



The Intercell 10 B38+B39 is an outdoor TDD-LTE dual carriers base station with 2*(2*10W) output power (each carrier supports 2x2 MIMO with 10W output each RF channel). The unit is compact, light weight, and easy to deploy. The Intercell 10 B38+B39 offers excellent performance, helping operators provide better coverage and higher capacity with minimal effort.

- Maximum 2 * 192 RRC connected users and 2 * 96 active users
- 5/10/15/20 MHz operation bandwidth
- All IP based backhaul, many IP backhaul methods can be used, including RJ45 Ethernet, SFP

hAP ac³ LTE6 kit

mt.lv/p/507 



hAP ac³ LTE6 kit features our newest CAT6 LTE modem. It enables carrier aggregation, allowing you to use the LTE connection with speed up to 300 Mbps. It works by using multiple LTE bands at the same time. A huge advantage when there are a lot of LTE users in the area. Depending on the service provider, we have seen Internet speed doubling after switching to CAT6. The new enclosure allows mounting the device vertically or horizontally. A wall mount set is also included.

- 5 Gigabit Ethernet ports
- Strong dual-band 2.4GHz / 5 GHz wireless
- 256 MB of RAM
- Powerful quad-core CPU
- Category 6 LTE modem (300 Mbps Downlink, 50 Mbps Uplink)
- Carrier aggregation
- USB

LDF LTE6 kit

mt.lv/p/515 



This outdoor wireless system with a built-in antenna can provide a connection even in the most remote locations. Tiny, powerful, can be used with any satellite TV dish with an offset mount. Since the LDF is a tiny little package, it makes shipping and deployment fast, simple and low cost.

- Attach it to any satellite TV dish, and the dish will act as a reflector, greatly amplifying the signal
- With a solid IP68 rating LDF LTE6 kit can withstand dust, dirt and sand, as well as temporary immersion in water
- Category 6 LTE modem (300 Mbps Downlink, 50 Mbps Uplink)
- Carrier aggregation
- Passive PoE input 802.3 af/at, 12-57 V
- 10/100 Mbps Ethernet, MiniPCI-e

LHGG LTE6 kit

mt.lv/p/526 



Great solution for great distances. With Gigabit Ethernet, an upgraded dual-core CPU, powerful 17 dBi antenna and a massive heat sink, you can trust the LHGG LTE6 kit to handle any challenge!

- High-speed Internet even when your phone has no signal!
- 300 Mbps CAT6 LTE modem
- Large high-gain antenna
- Gigabit Ethernet with PoE-in
- Powerful dual-core CPU and 256MB RAM
- Grid antenna design – perfect for harsh, windy weather

MikroTik GPEN concept can replace any existing or future GPON solution. It provides all the benefits of GPON, but utilizes well-proven, simple and inexpensive Ethernet solutions.

GPEN doesn't require expensive GPON OLT equipment in your server rooms, just a regular switch port!

Similar to GPON, GPEN solution will require clients to provide power, but instead of powering GPON's ONT device, power will be used for extending the Ethernet cable (with our GPeR devices) and powering the netPower device. That is the GPEN analogue of GPON Passive optical splitters – netPower provides additional functionality and possibilities. And the best part of this technology – it give you all the flexibility for a fraction of the price. You can connect netPower to your server room by Ethernet, Active optical line or use it to power one end of point-to-point backbone wireless link. GPEN – the evolution of GPON done right!

1. GPEN11 or GPEN21
2. GPeR
3. GPeR IP67 Case
4. netPower 15FR

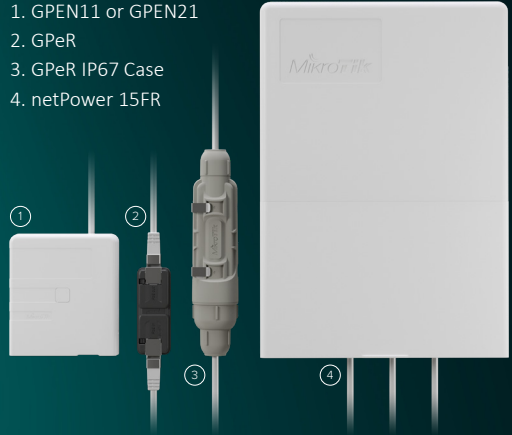

GPeR

mt.lv/p/455 

Extend Ethernet cable by additional hop with the Gigabit Passive Ethernet Repeater

- 100 - 150 m to regular network devices, and up to 210 m to another GPeR unit
- Up to 1,500 m total
- Two Gigabit Ethernet ports
- PoE-in- 802.3af/at or Passive PoE (24- 57 V)
- PoE-out- jumper selectable passive PoE Passthrough

GPeR IP67 case

mt.lv/p/428 

A sturdy and affordable outdoor enclosure for GPeR units. It can be easily mounted on walls and poles. Despite the name, meticulous testing revealed that in real life the enclosure has an IP68 rating with protection from immersion in water, as well as protection from dust.





GPEN11

mt.lv/p/450 

A power injector that can be mounted on a wall, and will power your uplink devices with PoE.

- 2 Gigabit Ethernet ports
- Passive PoE-out
- Can be used to power the ISP equipment, using power from the user premises.
- Has a designated space for an ISP sticker on the front. Sticker size: 6,6 x 2,54 cm.

GPEN21

<http://mt.lv/GPENpdf> 



A smart power injector that serves as an advanced software controlled repeater that can power your uplink devices with PoE.

- 2 Gigabit Ethernet ports
- SFP port for fiber to copper functionality Interface management and monitoring
- VLAN support
- SNMP reporting
- Traffic control and shaping
- Has a designated space for an ISP sticker on the front. Sticker size: 6,6 x 2,54 cm.
- Passive PoE-out
- 802.3af/at PoE-in

netPower 15FR

mt.lv/p/500 



A 18 port reverse PoE switch in outdoor enclosure. Part of our GPEN concept – aimed to bring the speed and versatility of fiber networking while using the advantages of Ethernet. It is an easy to deploy, low-cost way for any ISP to deliver the Internet to individual apartments.

- 15 reverse PoE-in ports
- Extra PoE-out port- you can use it to power an aggregate link
- Two SFP ports
- Can draw the necessary power even from a single client
- Dual boot feature that allows to choose RouterOS or SWOS

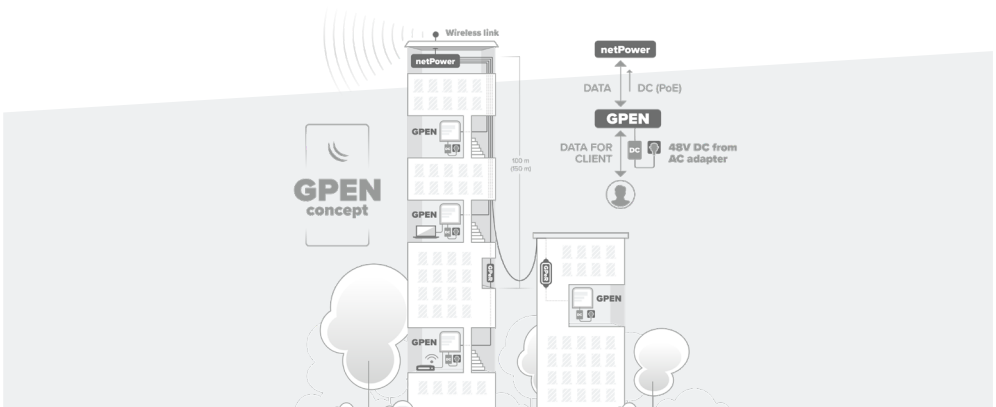

New MikroTik IoT products – Internet of things has never been so affordable. MikroTik is bringing you new, powerful IoT products for the fraction of the cost you would expect.

LtAP LR8 LTE kit

mt.lv/p/531 

A compact all-in-one solution with LTE, GPS and wireless support for LoRa® in a rugged heavy-duty case.



- All-in-one: High-speed LTE, GPS, Internet-of-things
- 2.4 GHz AP in a rugged heavy-duty case
- 3 MiniSIM slots –perfect for roaming
- Many powering options, including automotive
- Ready for “The Things Network” integration
- Gigabit Ethernet with PoE-in

KNOT

mt.lv/p/535 

The newest addition to the MikroTik IoT product family – KNOT – is a truly universal device with exceptional connectivity options and protocol support. It is an IoT Gateway that uses Narrow Band and CAT-M technology. Because of the low cost, low bandwidth cellular connection, it is supported by countless mobile operators around the globe.



- CAT-M/NB technology
- 2.4 GHz wireless
- Bluetooth
- 2x 100 Mbps Ethernet ports
- PoE-in & PoE-out
- GNSS, GPIO and RS485/Modbus
- MicroUSB
- Brings wireless connectivity to wired sensors and actuators, such as electricity meters and relays

KNOT LR9 kit

mt.lv/p/551 

An out-of-the-box 902-928 MHz IoT Gateway solution for LoRa® technology. For ultimate versatility and cost-effectiveness. The first gateway with a CAT-M interface for LoRa®!



- Supports LoRa® 902-928 MHz frequency
- A pre-installed UDP packet forwarder
- CAT-M/NB technology
- 2.4 GHz wireless
- Bluetooth
- 2x 100 Mbps Ethernet ports
- PoE-in & PoE-out
- GNSS, GPIO and RS485/Modbus
- MicroUSB
- Brings wireless connectivity to wired sensors and actuators, such as electricity meters and relay

KNOT LR8 kit

mt.lv/p/550 



An out-of-the-box 863-870 MHz IoT Gateway solution for LoRa® technology. For ultimate versatility and cost-effectiveness. The first gateway with a CAT-M interface for LoRa®!

- Supports LoRa® 863-870 MHz frequency
- A pre-installed UDP packet forwarder
- CAT-M/NB technology
- 2.4 GHz wireless
- Bluetooth
- 2x 100 Mbps Ethernet ports
- PoE-in & PoE-out
- GNSS, GPIO and RS485/Modbus
- MicroUSB
- Brings wireless connectivity to wired sensors and actuators, such as electricity meters and relay

TG-BT5-OUT

mt.lv/p/549 

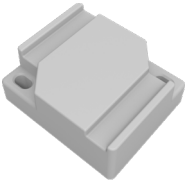

An outdoor heavy-duty Bluetooth tag for the MikroTik KNOT or other IoT asset-tracking/telemetry setups. Built-in temperature sensors and accelerometer. Cast in industrial grade molds for maximum protection.

- Built-in battery that will last for years
- Magnet activation
- BLE (Bluetooth Low Energy) 5.2 with Silabs BG22
- Built-in accelerometer
- iBeacon, Eddystone, Mikrotik telemetry
- Built-in temperature sensors
- Cast in industrial-grade molds
- IP69k ingress protection rating

TG-BT5-IN

mt.lv/p/548 



Indoor Bluetooth tags for the MikroTik KNOT or other IoT asset-tracking/telemetry setups.

- Built-in battery that will last for years
- Magnet activation
- BLE (Bluetooth Low Energy) 5.2 with Silabs BG22
- Built-in accelerometer
- iBeacon, Eddystone, Mikrotik telemetry

868 Omni antenna

mt.lv/p/554 



The upgrade of our antenna kit for LoRa® with a 6.5 dBi Omni antenna for 824-960 MHz, 1m long SMA cable and mechanical holder for quick and easy mast attachment. Smaller size, increased durability, and added IP66 water resistance.

After reviewing your suggestions, we went back to the drawing board and redesigned the Antenna kit for LoRa®. The new kit offers significantly higher durability in a smaller package – without sacrificing performance. The improved cable durability and the added IP66 water resistance with protection against powerful jets make this kit an excellent choice for all kinds of marine and coastal projects.

Mount this antenna on a 25-50 mm mast or on the wall and enjoy the superb coverage!

R11e-LR8

mt.lv/p/189 



Concentrator Gateway card for LoRa® technology in mini PCIe form factor. It enables LoRa® connectivity for any MikroTik product that has mini PCIe slot with connected USB lines.

- 863-870 MHz (EU863-870, RU864-870, IN865-867)
- Receive max sensitivity -137 dB @ SF12
- RF Output power 863-870 MHz 20 dBm

R11e-LR9

mt.lv/p/464 



Concentrator Gateway card for LoRa® technology in mini PCIe form factor. It enables LoRa® connectivity for any MikroTik product that has mini PCIe slot with connected USB lines.

- 902-928 MHz (AU915-928, US902-928, AS923, KR920-923)
- Receive max sensitivity -137 dB @ SF12
- RF Output power 902-928 MHz 23 dBm

wAP LR8 kit

mt.lv/p/465 



An out-of-the-box solution to use Gateway solution for LoRa® technology

- supports 863-870 MHz frequency (EU863-870, RU864-870, IN865-867)
- a pre-installed UDP packet forwarder
- 2.4 GHz WLAN interface
- renowned weatherproof wAP form-factor
- 10/100 Ethernet port that could be used as a backend

wAP LR9 kit

mt.lv/p/466 



- supports 902-928 MHz frequency (AU915-928, US902-928, AS923, KR920-923)
- a pre-installed UDP packet forwarder
- 2.4 GHz WLAN interface
- renowned weatherproof wAP form-factor
- 10/100 Ethernet port that could be used as a backend

Our LoRa® are ready to work with “The Things Network” - the famous open source infrastructure that provides free LoRa® network coverage and has tons of apps for your needs. With the help of “The Things Network” you can get started with the Internet of things within a day. And it is easily upgradable to enterprise-grade network “The Things Industries”.

Cattle tracking, smart irrigation, level monitors for liquids, smart pulse sensors and thermostats, smart parking and so on – the possibilities are endless. And the setup is so easy, anyone can learn it. There is a large community of developers and enthusiasts all around the globe – you will never be alone with your questions and ideas regarding the LoRa® network. No need to reinvent the wheel – join “The Things Network” to save time and energy with smart solutions!

With this product family we aim to provide the most affordable LoRa® solution to date without compromising quality or performance.

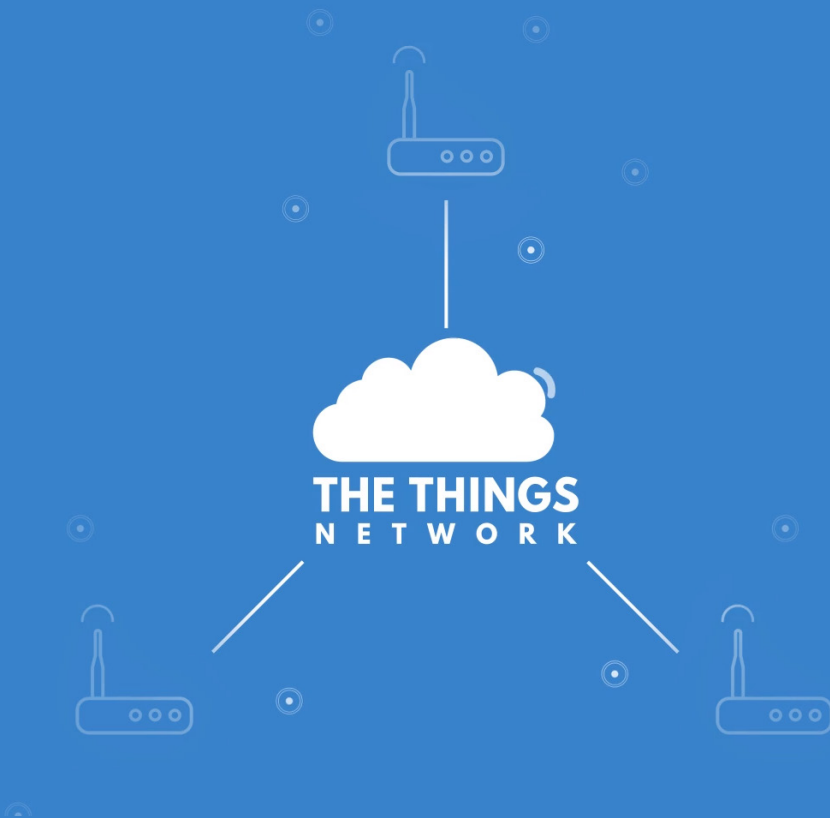

Chateau LTE12 kit

mt.lv/p/288 



A high-speed, dual-band home access point with CAT12 LTE for really fast Internet anywhere, anytime.

- Category 12 LTE modem (600 Mbps Downlink, 150 Mbps Uplink, 3x Carrier Aggregation)
- 5 x Gigabit Ethernet ports
- Quad-core 716 Mhz CPU
- 256 MB RAM
- 802.11 b/g/n 2.4 GHz dual-chain high power wireless
- 802.11 a/n/ac 5 GHz dual-chain high power wireless
- Micro SIM slot
- 4 powerful (4x4 MIMO compatible!) integrated antennas with an option to connect 2 external LTE antennas via SMA
- full size USB port

Audience LTE6 kit

mt.lv/p/427 



Stylish tri-band home access point with LTE CAT6 support and meshing technology

- Category 6 LTE modem (300 Mbps Downlink, 50 Mbps Uplink, Carrier Aggregation)
- Two Gigabit Ethernet ports
- Quad-core 716 Mhz CPU
- 256 MB RAM
- 802.11 b/g/n 2.4 GHz dual-chain high power wireless
- 802.11 a/n/ac 5.18- 5.3 GHz dual-chain high power wireless
- 802.11 a/n/ac 5.5- 5.85 GHz quad-chain high power wireless
- Micro SIM slot
- PoE-in

Audience

mt.lv/p/321 

Audience is a tri-band (one 2.4 GHz & two 5 GHz) home access point with LTE support and meshing technology. If you need Wi-Fi in a huge building with all kinds of obstacles, simply add more Audience devices to your network – with a press of a button they will sync seamlessly and create a single Wi-Fi network to cover the whole premises. The initial setup is also very simple – download the iOS or Android MikroTik app, it will connect to the router and guide you through a quick setup process.

In some cases a single Audience unit might be able to replace several other routers – in our tests it covered 1858 m² (20000 square feet) easily. It depends on the amount of obstacles, Wi-Fi clients and interference, so results may vary.



PL7510Gi

mt.lv/p/268 



Next level product for even faster power-line connection without long LAN cables

- Gigabit Ethernet
- Use up to 8 PWR-Line devices to build your network
- Passive 24 V PoE-out
- Much faster than usual power-line data devices
- Backwards compatible with PL64xx and PL74xx series

PL7400

mt.lv/p/454 



Power adapter with PWR-LINE functionality for microUSB powered MikroTik router (Type C power plug)

- 10/100 Ethernet
- Built-in microUSB cable for MikroTik products with microUSB port, like hAP mini or hAP lite.
- Type C power plug (commonly used in Europe, South America and Asia)

PL6400

mt.lv/p/453 



Power adapter with PWR-LINE functionality for microUSB powered MikroTik router (Type A power plug)

- 10/100 Ethernet
- Built-in microUSB cable for MikroTik products with microUSB port, like hAP mini or hAP lite.
- Type A power plug (commonly used in USA, Canada, Mexico, Thailand)

PWR-Line AP

EU: mt.lv/p/436 US: mt.lv/p/437 

The PWR-Line AP is a small Wi-Fi access point, made as an accessory to your existing network, for places, where your signal or your cable is unable to reach. Especially useful in homes with thick walls, where you can extend Wi-Fi coverage to those rooms, where signal is poor, without having to re-wire your house. Simply plug this device directly into one of the LAN ports of your MikroTik router, and add another one somewhere further in your premises. They will link together through the power lines. You can install up to eight PWR-LINE devices to further build your network.

- Extend your network without extra LAN cables
- Connects over power lines
- 2.4 GHz 802.11b/g/n dual chain wireless
- 10/100 Mbps Ethernet
- 650 MHz CPU, 64 MB RAM
- EU and US plug models available



RB5009UG+S+IN

mt.lv/p/543 

The ultimate heavy-duty home lab router - unprecedented processing power in such a small form factor.

- Marvell Armada 4-core ARMv8 1.4 GHz CPU
 - 1GB of DDR4 RAM and 1GB NAND storage
 - 1x 2.5 Gigabit Ethernet, 7x Gigabit Ethernet
 - 10G SFP+ cage
 - Indoor desktop metal enclosure, that works as a massive heat sink
 - Full size USB v3.0
- With the K-79 mounting kit, you can fit four of these new routers in a single 1U rackmount space!

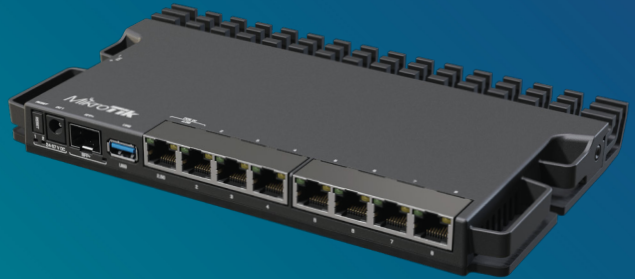

Add more RB5009's when necessary - you can fit up to 4 of these devices in a single rackmount. Grow your business with MikroTik!

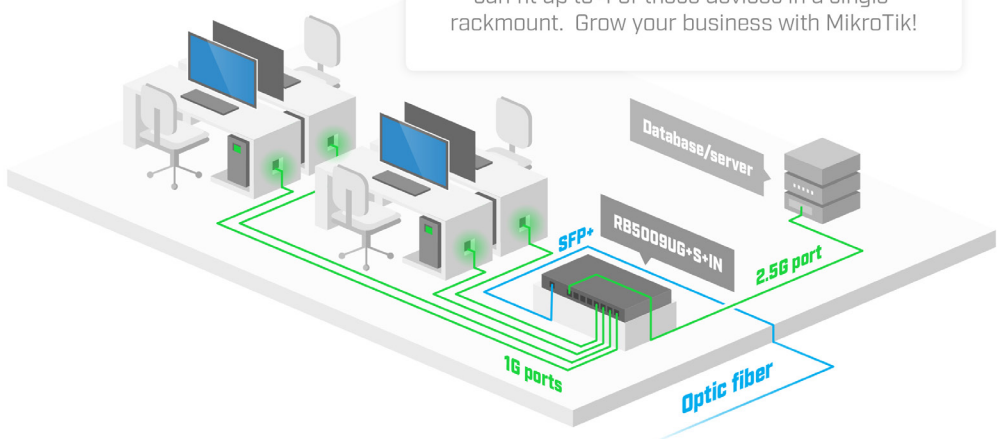

CCR2004-1G-12S+2XS

mt.lv/p/513 

The Connectivity Router- your best companion when it comes to SFP, SFP+ and SFP28 management! 1, 10 and 25 Gbps ports in a single device to make your life easier.



- 12 x 10G SFP ports
- 2 x 25G SFP28 ports
- MikroTik router with the most powerful single-core performance so far. It provides incredible results in single tunnel (up to 3.4 Gbps) and BGP feed processing
- Dual redundant power supply
- 4GB DDR4 RAM, 128 MB NAND
- AL32400 1700 MHz quad-core CPU

CCR2004-16G-2S+

mt.lv/p/541 

This powerful and affordable router crushes all previous CCR models in single-core performance.



- Annapurna Labs Alpine v2 CPU with 4x 64-bit ARMv8-A Cortex-A57 cores running at 1.7GHz
- 4GB of DDR4 RAM and 128MB of NAND storage
- 16 x Gigabit Ethernet ports
- 2 x 10G SFP+ cages
- Full size USB, RJ-45 console port
- 1U active cooling rackmount case
- Built-in dual redundant power supplies

hEX series

The hEX series of devices are small form factor Ethernet routers with neat plastic design enclosures. They have a total of five ports.



hEX lite

mt.lv/p/56 

A small, but powerful five port Ethernet router in a nice plastic case.

- 850 MHz CPU, 64 MB RAM
- Compact size



hEX PoE lite

mt.lv/p/267 

This model supports PoE output on it's Ethernet ports, so you can power other devices.

- 5x 10/100 Mbps Ethernet ports
- 650 MHz CPU, 64 MB RAM
- Ethernet ports 2-5 can power other PoE capable devices



hEX

mt.lv/p/262 

The hEX is a small and powerful router with Gigabit Ethernet, IPsec acceleration and more.

- 5 Gigabit Ethernet ports
- Dual core 880 MHz CPU, 256 MB RAM
- IPsec hardware encryption (~470 Mbps) support
- Support for The Dude server package
- microSD slot and USB



hEX PoE

mt.lv/p/295 

This model also has PoE output capability, but includes Gigabit Ethernet ports and an SFP cage.

- 5 Gigabit Ethernet ports
- SFP port for 1.25 Gigabit connectivity
- Ethernet ports 2-5 can power other PoE capable devices
- 800 MHz CPU, 128 MB RAM

hEX S is a six port wired Gigabit router for locations where wireless connectivity is not required. Compared to the hEX, the hEX S also features an SFP port and PoE output on the last port.



- Dual Core 880 MHz CPU
- 256 MB RAM
- 1.25Gbit/s SFP cage
- USB 2.0 and microSD slot
- 12 V- 57 V input support by PoE or power jack
- 802.3at/af support
- IPsec hardware encryption (~470 Mbps)
- Dude Server package support

PowerBox series

The PowerBox series of devices are Ethernet routers in outdoor enclosures, ready to be mounted in any weather conditions. They are capable to power MikroTik routers and other supported devices through PoE (Power over Ethernet).



PowerBox

The basic model is good for 10/100 Mbit devices and lower bandwidth requirements.

- 5x 10/100 Mbps Ethernet ports
- 650 MHz CPU, 64 MB RAM



PowerBox Pro

The professional model adds Gigabit ports and a more capable CPU.

- 5 Gigabit Ethernet ports
- SFP port for 1.25 Gigabit connectivity
- 800 MHz CPU, 128 MB RAM

RB2011iL-IN

[mt.lv/p/142](#) 



The RB2011 lite model comes in a desktop case and features a PoE out port, just like all the other models.

- 600 MHz CPU, 64 MB RAM
- Desktop case

RB2011iL-RM

[mt.lv/p/161](#) 



The RM model is similar, but comes in a larger, rackmountable enclosure.

- 600 MHz CPU, 64 MB RAM
- Rackmount case

RB2011iLS-IN

[mt.lv/p/153](#) 



This device includes an SFP port for fiber and copper modules. See the Accessories chapter for recommended modules.

- SFP port for 1.25 Gigabit connectivity
- 600 MHz CPU, 64 MB RAM
- Desktop case

RB2011UiAS-IN

[mt.lv/p/157](#) 



The U models include more RAM and a USB port.

- SFP port for 1.25 Gigabit connectivity
- 600 MHz CPU, 128 MB RAM
- LCD display and USB
- Desktop case

RB2011UiAS-RM

[mt.lv/p/162](#) 



Similar to the above model, but comes in a rackmountable enclosure.

- SFP port for 1.25 Gigabit connectivity
- 600 MHz CPU, 128 MB RAM
- LCD display and USB
- Rackmount case

RB3011UiAS-RM

mt.lv/p/271 



The RB3011 is a multi port device, our first to be running an ARM architecture CPU for higher performance than ever before.

- 10 Gigabit Ethernet ports
- Dual core ARM 1.4 GHz CPU, 1 GB RAM
- SFP port for 1.25 Gigabit connectivity
- LCD display and USB 3.0

RB4011iGS+RM

mt.lv/p/422 

RB4011 series - amazingly powerful routers with ten Gigabit ports, SFP+ 10Gbps interface and IPsec hardware acceleration for a great price!

The RB4011 uses a quad core Cortex A15 CPU, same as in our carrier grade RB1100AHx4 unit. The unit is equipped with 1 GB of RAM, can provide PoE output on port #10 and comes with a compact and professional looking solid metal enclosure in matte black.

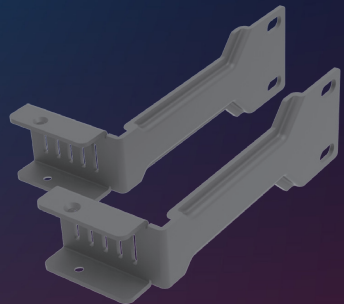

- Quad-core 1.4 GHz CPU
- 1 GB of RAM
- All metal passive cooled enclosure

RB1100AHx4 Dude Edition

mt.lv/p/312 

The RB1100AHx4 Dude Edition has an Annapurna Alpine AL21400 CPU with four Cortex A15 cores clocked at 1.4 GHz each, for a maximum throughput of up to 7.5 Gbps. The device supports IPsec hardware acceleration and is faster at it than any previous RouterBOARD device (up to 2.2 Gbps with AES128).

The unit comes in a 1U rackmount case, 13 Gigabit Ethernet ports, RS232 serial port and dual redundant power supplies (with -48 V DC telecom power and 802.3at/af support). The RB1100AHx4 Dude edition features several high speed storage connectors (two SATA and two M.2) for storing The Dude database, proxy cache or for any other storage intensive task. A 60 GB M.2 drive is already included.

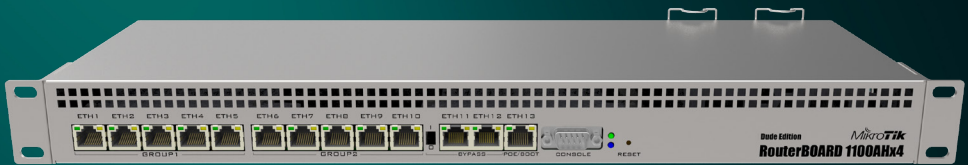

- 13 Gigabit Ethernet ports
- Four core Annapurna Alpine 1.4 GHz ARM CPU, 1 GB RAM
- Maximum throughput of up to 7.5 Gbps
- IPsec hardware acceleration (up to 2.2 Gbps with AES128)
- Dual redundant power supplies (with -48 V DC telecom power and 802.3at/af support)
- Two SATA and two M.2 connectors for storage
- 60 GB M.2 drive already installed

RB1100AHx4

mt.lv/p/327 

Powerful 13 Gigabit Ethernet port router in a rackmount case with dual redundant power supplies.



- 13 Gigabit Ethernet ports
- Four core Annapurna Alpine 1.4 GHz CPU, 1 GB RAM
- Maximum throughput of up to 7.5 Gbps
- IPsec hardware acceleration of up to 2.2 Gbps with AES128
- Dual redundant power supplies (with -48 V DC telecom power and 802.3at/af support)

The Cloud Core Router series of devices are powered by our fastest networking processors, based on the Tiler architecture. The CCR series is the top of the line Ethernet routers for your most demanding needs.

The CCR series devices use Tiler multicore CPUs, which are so powerful, that the devices can easily handle all port routing without a switch chip. All of the CCR series devices support hardware IPsec acceleration.

CCR1009-7G-IC-PC

[mt.lv/p/296](#) 



Tiler 9-core CPU, Gigabit Ethernet, IPsec acceleration and combo port. The combo port allows you to select which of the two options you wish to use, an SFP port or another Gigabit copper port. The passively cooled device makes this device absolutely quiet.

- 7 Gigabit Ethernet ports
- Combo (Gigabit Ethernet or SFP) port
- 1 GB RAM
- Silent passive cooling enclosure

CCR1009-7G-IC-IS+PC

[mt.lv/p/297](#) 



Tiler 9-core CPU, Gigabit Ethernet, IPsec acceleration, combo port, and additional SFP+ port for 10G connectivity.

- Eight Gigabit Ethernet ports
- Combo (Gigabit Ethernet or SFP) port
- 2 GB RAM
- LCD touch screen, smart card slot, microSD slot
- Silent passive cooling enclosure

CCR1009-7G-IC-IS+

[mt.lv/p/298](#) 



The same Tiler 9-core CPU, Gigabit Ethernet, IPsec acceleration, combo port, but in a rackmount case with built in dual PSU.

- Eight Gigabit Ethernet ports
- Combo (Gigabit Ethernet or SFP) port
- SFP+ port for 10 Gbps connectivity
- 2 GB RAM
- LCD touch screen, smart card slot, microSD slot
- Dual power supplies built-in for redundancy
- 1U rackmount enclosure

CCR1016-12G

mt.lv/p/165 

Powerful 16 core rackmount router with 12 Gigabit Ethernet ports.



- 12 Gigabit Ethernet ports
- Tilerla 16-core CPU, 1.2 GHz per core, 2 GB RAM
- Up to 17.8 Million pps throughput in Fast Path mode (wire speed)
- Up to 12 Gbps throughput with RouterOS queue/firewall configuration
- LCD touch screen
- 1U rackmount enclosure
- full size USB slot and dual PSU for redundancy

CCR1016-12S-IS+

mt.lv/p/221 

Powerful 16 core rackmount router with 12 SFP ports and one SFP+ for 10 Gigabit connectivity.



- 12 SFP ports for 1.25 Gigabit connectivity
- 1 SFP+ port for 10 Gigabit connectivity
- Tilerla 16-core CPU, 1.2 GHz per core, 2 GB RAM
- Dual power supplies built-in for redundancy
- LCD touch screen
- 1U rackmount enclosure
- full size USB slot and dual PSU for redundancy

CCR1036-12G-4S

mt.lv/p/149 

Carrier grade 36 core rackmount router with 12 Gigabit Ethernet ports and four SFP ports for optical fiber connectivity.



- 12 Gigabit Ethernet ports
- 4 SFP ports for 1.25 Gigabit connectivity
- Tilerla 36-core CPU, 1.2 GHz per core, 4 GB RAM
- Up to 24 Mpps throughput in Fast Path mode (wire speed)
- Up to 16 Gbps throughput with RouterOS queue/firewall configuration
- LCD touch screen
- 1U rackmount enclosure
- full size USB slot and dual PSU for redundancy

CCR1036-12G-4S-EM

mt.lv/p/185 

The same carrier grade 36 core rackmount router with 12 Gigabit Ethernet ports and four SFP ports for optical fiber connectivity, but with more RAM for high intensity tasks.



- 8 GB of RAM
- full size USB slot and dual PSU for redundancy

CCR1036-8G-2S+

mt.lv/p/196 

The CCR1036-8G-2S+ is a high performance networking router with eight Gigabit ports, two SFP+ ports for 10G connectivity and dual power supplies for redundancy. Powered by a 36 core CPU, this router is able to perform the most complicated routing and management tasks, for managing large networks with high bandwidth requirements.

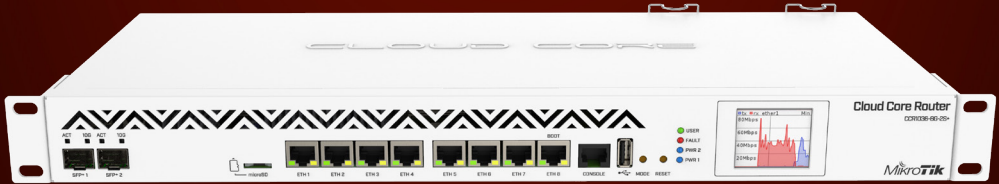

Each of its ports is directly connected to the Tilera networking CPU, with no ports sharing any bandwidth, guaranteeing the best performance and highest reliability. The CPU supports IPsec hardware accelerated encryption, so you can use it also as a high performance VPN gateway to ensure the best encryption between important locations, without sacrificing connection speed.

The M.2 slot allows to install a high speed SSD disk, for using a local user database, proxy storage or for other features.

- Tilera 36-core CPU, 1.2 GHz per core, 4 GB RAM
- 8 Gigabit Ethernet ports
- 2 SFP+ ports for 10 Gigabit connectivity
- Up to 41.5 Mpps throughput in Fast Path mode (wire speed)
- Up to 28 Gbps throughput with RouterOS queue/firewall configuration
- LCD touch screen and full size USB port
- 1U rackmount enclosure with two power supplies for redundancy

CCR1036-8G-2S+EM

mt.lv/p/197 



The same carrier grade 36 core rackmount router with 8 Gigabit Ethernet ports and two SFP+ 10G ports for optical fiber connectivity, but with more RAM for high intensity tasks.

- 8 GB of onboard RAM

CCR1072-1G-8S+

Our flagship router, the CCR1072, is powered by a Tiler 72 core CPU, each core is clocked at 1 GHz, and to fully utilize this power, the CCR1072 is equipped with eight independently connected 10G SFP+ ports.

Thanks to the unique 72 core processor and ports that are directly connected to the CPU, the CCR1072 is capable of over 120 million packets per second throughput.

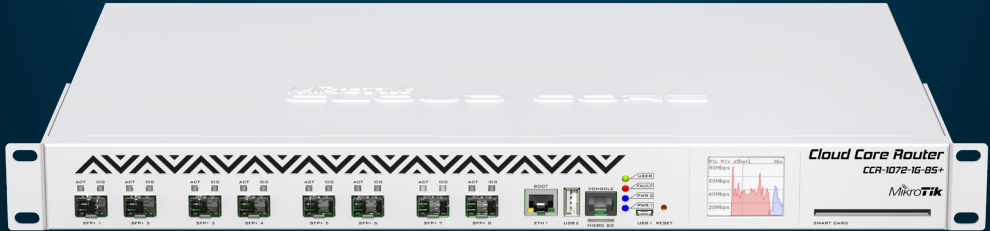

The unit comes equipped with two removable (hot plug) power supplies for redundancy, smart card slot, eight SFP+ ports and 16 GB of built in ECC RAM.

The CCR1072 also has two built-in M.2 slots, microSD slot and 2x USB ports for adding storage, to use for proxy cache, user manager and other features. The M.2 slots accept 800 mm Key-M x4 PCIe 2.0 modules.

Quick specifications

- 1 Gigabit Ethernet port
- 8 SFP+ ports for 10 Gigabit connectivity
- Tiler 72-core CPU, 1 GHz per core, 16 GB RAM
- Up to 120 Mpps throughput in Fast Path mode (wire speed)
- Up to 80 Gbps throughput
- Two built-in M.2 slots, microSD slot and 2x USB
- LCD touch screen
- Two hot swap power supplies for redundancy (two 12POW150 included)
- 1U rackmount enclosure
- PW48V-12V150W can be used as an alternative



Our smaller SOHO switches have five Gigabit Ethernet ports and an SFP port for optical fiber connectivity. The devices are powered by RouterOS or SwOS, our switch operating system that gives you all the most important switch configuration options.



RB260GS

mt.lv/p/174 

The tiny desktop case is compact enough to mount in narrow places, mounting hooks provide possibility to wall mount it in any direction.

- Five Gigabit Ethernet ports
- SFP port for 1.25 Gigabit connectivity
- Powered by SwOS
- All the basic functionality for a managed switch, plus more



RB260GSP

mt.lv/p/218 

The P model also includes capability to power other devices.

- Ethernet ports 2-5 can power other PoE capable devices
- Powered by SwOS



CRS106-1C-5S

mt.lv/p/305 

A desktop size smart switch with a Gigabit Ethernet / SFP combo port and five SFP ports for optical fiber connectivity.

- Combo (Gigabit Ethernet or SFP) port
- 400 MHz CPU, 128 MB RAM
- A market leading solution for connecting up to six SFP devices
- Powered by RouterOS



FiberBox

mt.lv/p/328 

An outdoor switch with five SFP ports, ideal for locations where distance is restricting the use of regular Ethernet cables.

- 400 MHz CPU, 128 MB RAM
- Weatherproof outdoor case
- RJ45 SFP (S-RJ01) copper module already pre-installed in the first port
- Powered by RouterOS

CRS305-IG-4S+IN

mt.lv/p/429 

The CRS305 is a compact yet very powerful switch, featuring four SFP+ ports, for up to 10 Gbit per port. The device has a 1 Gbit copper ethernet port for management access and two DC jacks for power redundancy. The device is a very sleek and compact metallic case without any fans, for silent operation.

The device has a “Dual boot” feature that allows you to choose between two operating systems- RouterOS or SwOS. If you prefer to have a simplified operating system with only switch specific features, use SwOS. If you would like the ability to use routing and other Layer 3 features in your CRS, use RouterOS. You can select the desired operating system from RouterOS, from SwOS or from the RouterBOOT loader settings. All the feature set comes with a disruptive price, providing the best price/performance on the market.

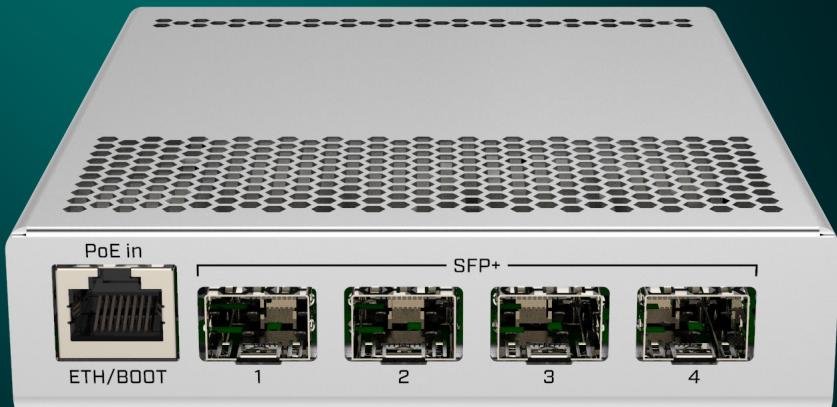

- 4 SFP+ ports
- 1 Gigabit Ethernet ports
- Non-Blocking throughput: 41 Gbps
- Switching capacity: 82 Gbps
- Forwarding rate: 61 Mpps
- 2 DC jack for redundancy
- Maximum power consumption: 12 W (with attachments 18 W)
- Supports PoE+ IEEE 802.3at/af and passive PoE 12-57 V
- Metal enclosure
- Fanless



CRS109-8G-1S-2HnD-IN

[mt.lv/p/239](#) 

A desktop size smart switch with 8 Gigabit Ethernet ports, SFP port for optical fiber connectivity and high power 2.4 GHz wireless.

- 8 Gigabit Ethernet ports
- SFP port for 1.25 Gigabit connectivity
- High power 2.4 GHz dual chain wireless
- 600 MHz CPU, 128 MB RAM
- LCD touch screen, microUSB port



CRS112-8G-4S-IN

[mt.lv/p/258](#) 

A desktop size smart switch with 8 Gigabit Ethernet ports and 4 SFP ports for optical fiber connectivity.

- 8 Gigabit Ethernet ports
- 4 SFP ports for 1.25 Gigabit connectivity
- 400 MHz CPU, 128 MB RAM



CRS112-8P-4S-IN

[mt.lv/p/349](#) 

A desktop size smart PoE switch with 8 Gigabit Ethernet ports, 4 SFP ports for optical fiber connectivity and PoE output.

- 8 Gigabit Ethernet ports with PoE output
- 4 SFP ports for 1.25 Gigabit connectivity
- 400 MHz CPU, 128 MB RAM
- 28 V 3.4 A power supply included
- Secondary DC jack on the back of the enclosure that supports 48-57 V power supply (optional)



CRS309-1G-8S+IN

[mt.lv/p/447](#) 

The CRS309-1G-8S+ is a very compact, yet powerful networking switch.

- 8 SFP+ ports for 10 Gigabit connectivity
- Dual-core 800 MHz CPU, 512 MB RAM
- Management Ethernet port with PoE power input
- RS232 serial port and a grounding terminal
- Dual boot feature that allows to choose RouterOS or SwOS
- Special rackmount ears for installing unit into the standard rack

CSS610-8G-2S+IN

mt.lv/p/521 



Portable, powerful and extremely cost-effective – this switch is an instant classic! The only \$99 10G SFP+ switch on the market!

- 8 x Gigabit Ethernet ports
- 2x SFP+ for 10G fiber
- Port-to-port forwarding, MAC filtering, VLAN
- Traffic mirroring, Broadcast storm control
- DC jack, PoE-in

CRS326-24G-2S+IN

mt.lv/p/514 



A home network setup doesn't have to be a compromise. This compact and quiet switch is packing some serious server room grade features. CRS326-24G-2S+IN provides all the basic functionality for a managed switch, and even more: port-to-port forwarding, MAC filtering, VLAN configuration, traffic mirroring, bandwidth limitation and even adjust some MAC and IP header fields.

- 2x 10G SFP+ cages
- 24 x Gigabit Ethernet ports
- 512 MB RAM
- SwOS / RouterOS (Dual boot)
- Sufficient built-in CPU that can handle basic home user needs such as firewall, NAT and even some VPN
- DC jack, PoE-in

netPower 16P

mt.lv/p/516 



An outdoor 18 port switch with 16 Gigabit PoE-out ports and 2 SFP+. Power all your access points anywhere!

- The sturdy and compact outdoor enclosure allows the switch to be mounted in all kinds of environments – from damp attics and shafts to towers, masts and poles with hose clamps
- 16 x Gigabit Ethernet ports with PoE-out and two SFP+ ports for 10G fiber uplinks
- When using both the high and low voltage adapters, the netPower will automatically choose the correct PoE standard and voltage, based on the devices you connect to each port
- Compatible with MikroTik power supplies: 24HPOW, 48POW, 48V2A96W

netPower Lite 7R

mt.lv/p/519 



An outdoor reverse PoE switch with Gigabit Ethernet and 10G SFP+ ports. Cut costs, not speed – choose GPEN over GPON!

- 7 reverse PoE Gigabit Ethernet ports*) 2 x 10G SFP+ ports
- durable outdoor enclosure
- DC jack & 2-pin terminal for alternative powering
- Can be powered by a battery
- Deliver high-speed Internet to individual apartments easily

A remarkable outdoor switch for setting up an optical network that can even perform some light routing. The spiritual successor to the beloved FiberBox.

- 5x 1G SFP ports
- 4x 10G SFP+ ports
- Multiple powering options
- Different mounting options
- Sturdy outdoor case
- Gigabit Ethernet with PoE-in
- 10G networking over long distances

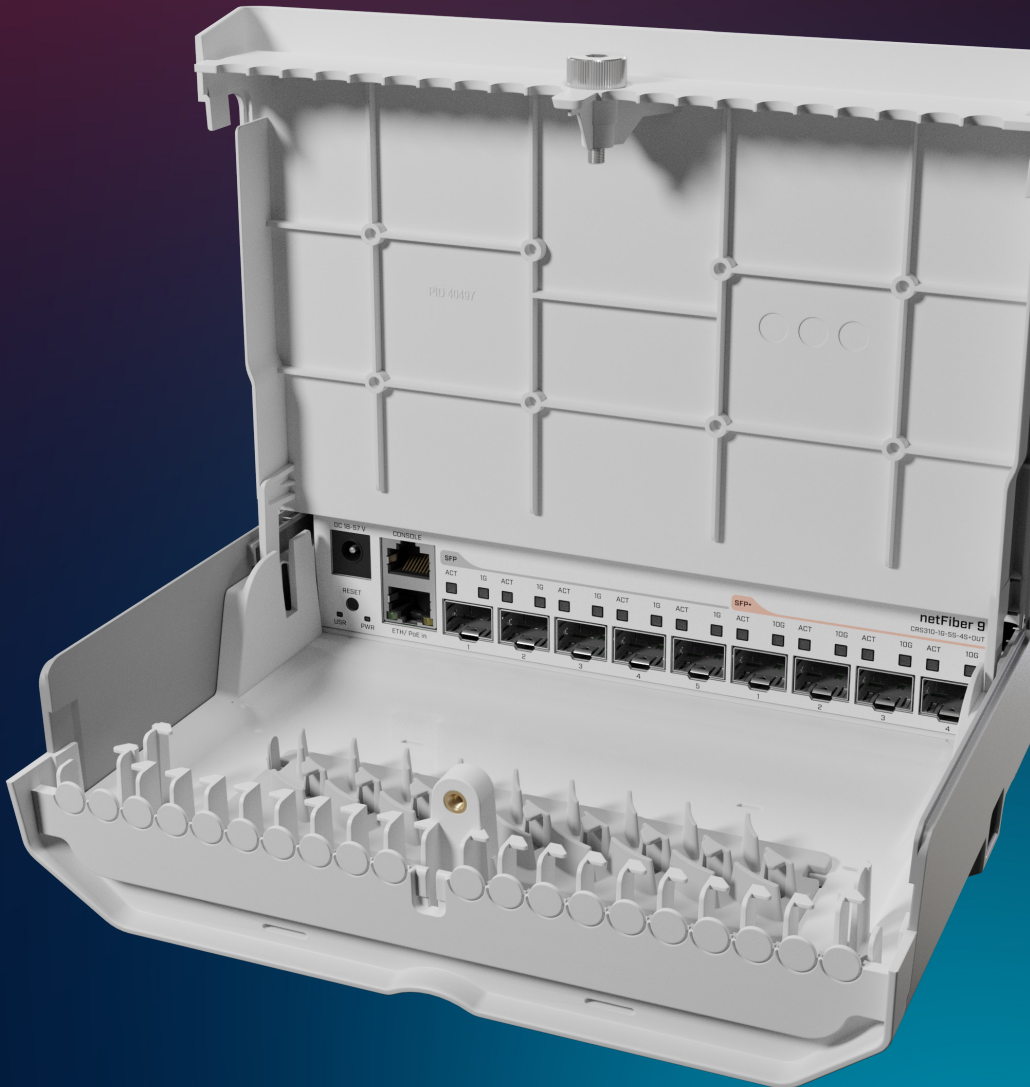

CRS328-24P-4S+RM

mt.lv/p/351 

The CRS328-24P-4S+RM is a 28 independent port PoE switch with multiple power options: Passive PoE, low voltage PoE, 802.3af/at (Type 1 “PoE” / Type 2 “PoE+”) with per port auto-sensing. The 4 SFP+ ports provide up to 10 Gigabit connectivity options via either optical fiber or Ethernet modules (not included).

CRS328-24P-4S+RM comes in a 1U rackmount case with 100-240 V AC 500 W power supply built-in.



- 24 Gigabit Ethernet ports with PoE output
- 4 SFP+ ports for 10 Gigabit connectivity
- 800 MHz CPU, 512 MB RAM
- Power output options: Passive PoE, low voltage PoE, 802.3af/at (Type 1 “PoE” / Type 2 “PoE+”) with auto-sensing
- 100-240 V AC 500 W power supply built-in
- Non-Blocking throughput: 64 Gbps
- Switching capacity: 128 Gbps
- Dual boot feature that allows to choose RouterOS or SwOS

CSS326-24G-2S+RM

mt.lv/p/308 

A 24 port Gigabit Ethernet switch with 2 SFP+ ports in 1U rackmount case.



- 24 Gigabit Ethernet ports
- 2 SFP+ ports for 10 Gigabit connectivity
- Powered by SwOS
- 1U rackmount case

CRS326-24G-2S+RM

mt.lv/p/314 

A 24 port Gigabit Ethernet router/switch with two SFP+ ports in 1U rackmount case, dual boot.



- 24 Gigabit Ethernet ports
- Two SFP+ ports for 10 Gigabit connectivity
- 800 MHz CPU, 512 MB RAM
- Dual boot feature that allows to choose RouterOS or SwOS
- 1U rackmount case

CRS312-4C+8XG-RM

[mt.lv/p/431](#) 



Switch of the future: the first MikroTik product with 10G RJ45 Ethernet ports and SFP+

- 8 10G Ethernet ports
- 4 Combo 10G Ethernet/SFP+ ports
- Combo ports can be software selected
- Dual power supply
- 1U rackmount case

CRS326-24S+2Q+RM

[mt.lv/p/424](#) 



Our fastest switch for the most demanding setups

- Two 40 Gbps QSFP+ ports
- 24 SFP+ ports for 10 Gigabit connectivity
- Dual boot feature that allows to choose RouterOS or SwOS
- Dual power supply
- 1U rackmount case

CRS354-48G-4S+2Q+RM

[mt.lv/p/479](#) 



Best price and best performance on the market – this 48 port switch will rock any setup, including 40 Gbps devices!

- Two 40 Gbps QSFP+ ports
- 48 Gigabit Ethernet ports
- 4 SFP+ ports for 10 Gigabit connectivity
- Dual power supply
- 1U rackmount case

CRS125-24G-IS-2HnD-IN

[mt.lv/p/202](#) 



A desktop size smart switch with 24 Gigabit Ethernet ports, an SFP port for optical fiber connectivity and high power 2.4 GHz wireless.

- 24 Gigabit Ethernet ports
- SFP port for 1.25 Gigabit connectivity
- High power 2.4 GHz dual chain wireless
- 600 MHz CPU, 128 MB RAM
- LCD touch screen, microUSB port

CRS354-48P-4S+2Q+RM

mt.lv/p/472 

If you are looking for a single switch that will put your network setup ahead of the curve and power all the necessary devices – look no further! The new CRS354-48P-4S+2Q+RM is an effective and adaptable rackmount solution for managing networks in the most demanding environments. Unlike many other switches out there, our products are made with the system administrator in mind.

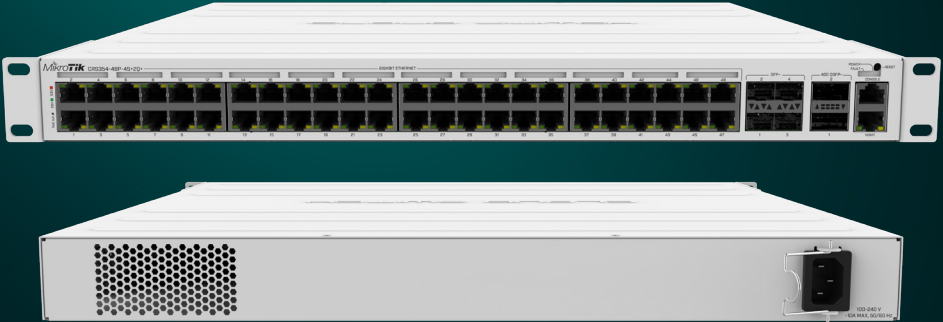

CRS354-48P-4S+2Q+RM is extremely functional, and it has the best price-point on the market – it will make the perfect addition to a professional setup. The total non-blocking throughput is 168 Gbps, switching capacity is 336 Gbps and the forwarding rate reaches 235 Mpps.

- Two 40 Gbps QSFP+ ports
- 48 Gigabit Ethernet ports with PoE-out
- Passive PoE, low voltage PoE, 802.3af/at (Type 1 “PoE” / Type 2 “PoE+”) with auto-sensing
- 4 SFP+ ports for 10 Gigabit connectivity
- 1U rackmount case

CRS317-1G-16S+RM

mt.lv/p/322 

A 1U rackmount manageable switch with 16 SFP+ ports for 10 Gigabit connectivity and a Gigabit Ethernet port for management.



- Gigabit Ethernet port
- 16 SFP+ ports for 10 Gigabit connectivity
- Dual core 800 MHz CPU, 1 GB RAM
- Dual boot feature that allows to choose RouterOS or SwOS
- Dual redundant power supplies
- Silent passive cooling enclosure
- 1U rackmount case

CRS328-4C-20S-4S+RM

The CRS328-4C-20S-4S+RM is a 28 independent port switch with a combo group.

This device has twenty SFP ports, four SFP+ ports for 10G modules and four combo ports, where you can choose to use SFP or RJ45 ports from the combo group. These ports can also be software selected, so if you have plugged in all eight cables, you can use scripting, to decide which four combo ports will be active.

The device has a “Dual boot” feature that allows you to choose between two operating systems- RouterOS or SwOS.

If you prefer to have a simplified operating system with only switch specific features, use SwOS. If you would like the ability to use routing and other Layer 3 features in your CRS, use RouterOS. You can select the desired operating system from RouterOS, from SwOS or from the RouterBOOT loader settings. All the feature set comes with our disruptive price, providing best price/performance on the market.

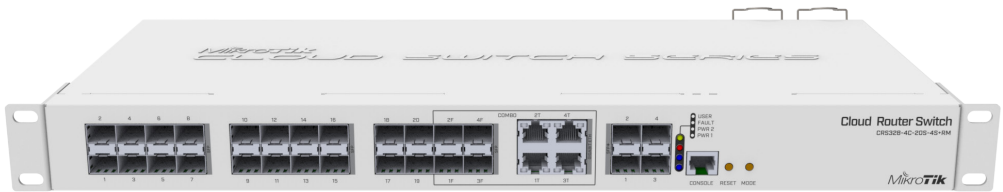

Switching features

- Non-blocking Layer 2 switching capacity
- 16K host table
- IEEE 802.1Q VLAN
- Supports up to 4K simultaneous VLANs
- Port isolation
- Port security
- Broadcast storm control
- Port mirroring of ingress/egress traffic
- STP / RSTP / MSTP
- Access Control List
- MikroTik neighbor discovery
- SNMP
- 10218-byte jumbo frames support
- IGMP snooping
- IEEE 802.3ad and static link aggregation

Quick specifications

- 20 SFP ports
- 4 ETH/SFP combo ports
- 4 SFP+ ports
- Non-Blocking throughput: 64 Gbps
- Switching capacity: 128 Gbps
- Forwarding rate: 95.2 Mpps
- RJ45 serial console port
- Dual PSU
- Maximum power consumption: 43 W
- Temperature based fan control
- 1U rackmount



SXTsq Lite2

mt.lv/p/361 

A compact, low-cost and lightweight outdoor 2.4 GHz 802.11b/g/n wireless device with an 10 dBi integrated antenna.

- 2.4 GHz 10 dBi antenna
- 802.11b/g/n dual chain wireless
- 10/100 Mbps Ethernet
- 650 MHz CPU, 64 MB RAM
- RouterOS level 3 license (CPE or Point-to-Point)

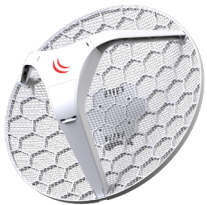

LHG 2

mt.lv/p/333 

An outdoor 2.4 GHz 802.11b/g/n wireless device with an 18 dBi integrated antenna for longer distances.

- 2.4 GHz 18 dBi antenna
- 802.11b/g/n dual chain wireless
- 10/100 Mbps Ethernet
- 650 MHz CPU, 64 MB RAM
- RouterOS level 3 license (CPE or Point-to-Point)

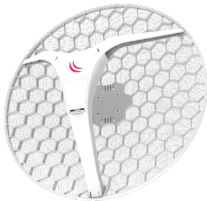

LHG XL 2

mt.lv/p/339 

An outdoor 2.4 GHz 802.11b/g/n wireless device with an extra large 21 dBi integrated antenna for even longer distances.

- 2.4 GHz 21 dBi antenna
- 802.11b/g/n dual chain wireless
- 10/100 Mbps Ethernet
- 650 MHz CPU, 64 MB RAM
- RouterOS level 3 license (CPE or Point-to-Point)

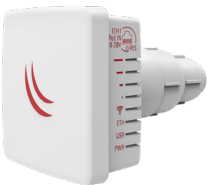

LDF 2

mt.lv/p/363 

A tiny 2.4 GHz system for super long distance links with satellite offset dish antennas.

- 40 mm diameter to fit any available satellite TV dish with an offset mount
- integrated 2.4 GHz 10 dBi antenna
- 802.11b/g/n dual chain wireless
- 10/100 Mbps Ethernet
- 650 MHz CPU, 64 MB RAM
- RouterOS level 3 (CPE or Point-to-Point)



SXT 2

mt.lv/p/168 

An outdoor 2.4 GHz 802.11b/g/n base station with a 10 dBi, 60 degree integrated sector antenna and Gigabit Ethernet.

- 2.4 GHz 10 dBi 60° sector antenna
- 802.11b/g/n high power dual chain wireless
- Gigabit Ethernet
- 600 MHz CPU, 64 MB RAM
- RouterOS level 4 license (AP, CPE or Point-to-Point)



mANTBox 2 I2s

mt.lv/p/417 

The mANTBox is based on our new mANT sector antennas, but also has a wireless router built right in. Powered by the RB911 device, the mANTBox comes ready to use with everything included. The device uses a high speed 600 MHz CPU, comes with the Gigabit Ethernet port and has a built in 802.11 b/g/n wireless device with up to 30 dBm output power.

- 2.4 GHz 12 dBi 120° sector antenna
- 802.11b/g/n, dual-chain
- Gigabit Ethernet
- 600 MHz CPU, 64 MB RAM
- RouterOS level 4 license (AP, CPE or Point-to-Point)

5 GHz integrated directionals _____

Up to 10 km distance _____



SXTsq Lite5

mt.lv/p/315 

A compact and lightweight outdoor wireless device with an integrated antenna. Perfect for point to point links of up to 12 kilometers or as a CPE unit.

- 5 GHz 16 dBi antenna
- 802.11a/n dual chain wireless
- 10/100 Mbps Ethernet
- 600 MHz CPU, 64 MB RAM
- RouterOS L3 (CPE or Point-to-Point)



SXTsq 5 High Power

mt.lv/p/332 

A compact, low-cost and lightweight outdoor 5 GHz 802.11a/n high power wireless device with a 16 dBi integrated antenna.

- 802.11a/n increased output power, dual chain wireless
- 10/100 Mbps Ethernet
- 600 MHz CPU, 64 MB RAM
- RouterOS level 3 license (CPE or Point-to-Point)



SXTsq 5 ac

mt.lv/p/336 

The SXTsq 5 ac is a compact and lightweight outdoor 5 GHz 802.11ac wireless device with an integrated antenna, perfect for Point-to-Point links or as a CPE unit.

- 5 GHz 16 dBi antenna
- 802.11a/n/ac dual chain wireless
- Gigabit Ethernet
- 716 MHz CPU, 256 MB RAM
- RouterOS level 3 license (CPE or Point-to-Point)



Disc Lite5

mt.lv/p/304 

An outdoor 5 GHz 802.11a/n/ac wireless device with a high gain 21 dBi integrated antenna.

- 5 GHz 21 dBi antenna
- 802.11a/n/ac dual chain wireless
- 10/100 Mbps Ethernet
- 600 MHz CPU, 64 MB RAM
- RouterOS level 3 license (CPE or Point-to-Point)



Disc Life5 ac

mt.lv/p/352

An outdoor 5 GHz 802.11a/n/ac wireless device with a high gain 21 dBi integrated antenna and Gigabit Ethernet for high speed on long distances.

- 5 GHz 21 dBi antenna
- 802.11a/n/ac high power dual chain wireless
- Gigabit Ethernet
- 716 MHz CPU, 256 MB RAM
- RouterOS level 3 license (CPE or Point-to-Point)

More than 10 km range



LHG XL 52 ac

mt.lv/p/309

Powerful 5 GHz backbone with 2.4 GHz backup for long-distance connection without downtime

- 2.4 GHz 18 dBi antenna
- 5 GHz 27 dBi antenna
- 802.11b/g/n and 802.11a/n/ac dual-chain high power wireless
- Gigabit Ethernet port
- 716 MHz quad-core CPU, 256 MB RAM



LHG 5

mt.lv/p/285

An outdoor 5 GHz 802.11a/n wireless device with a 24.5 dBi integrated antenna for long distances.

- 5 GHz 24.5 dBi antenna
- 802.11a/n dual chain wireless
- 10/100 Mbps Ethernet
- 600 MHz CPU, 64 MB RAM
- RouterOS level 3 license (CPE or Point-to-Point)



LHG HP5

mt.lv/p/316

An outdoor 5 GHz 802.11a/n high power wireless device with a 24.5 dBi integrated antenna for long distances.

- 5 GHz 24.5 dBi antenna
- 802.11a/n dual chain high power wireless
- 10/100 Mbps Ethernet
- 600 MHz CPU, 64 MB RAM
- RouterOS level 3 license (CPE or Point-to-Point)

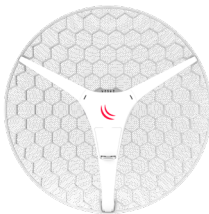

LHG XL HP5

mt.lv/p/317

An outdoor 5 GHz 802.11a/n high power wireless device with an extra large 27 dBi integrated antenna for extra large distances.

- 5 GHz 27 dBi antenna
- 802.11a/n dual chain high power wireless
- 10/100 Mbps Ethernet
- 600 MHz CPU, 64 MB RAM
- RouterOS level 3 license (CPE or Point-to-Point)

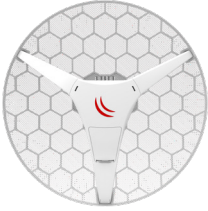

LHG 5 ac

mt.lv/p/335 

An outdoor 5 GHz 802.11a/n/ac wireless device with a 24.5 dBi integrated antenna and Gigabit Ethernet.

- 5 GHz 24.5 dBi antenna
- 802.11a/n/ac dual chain wireless
- Gigabit Ethernet
- 716 MHz CPU, 256 MB RAM
- RouterOS level 3 license (CPE or Point-to-Point)

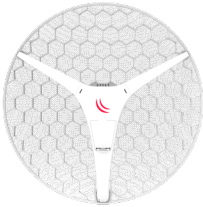

LHG XL 5 ac

mt.lv/p/340 

An outdoor 5 GHz 802.11a/n/ac wireless device with an extra large 27 dBi integrated antenna for extra long distances and Gigabit Ethernet.

- 5 GHz 27 dBi antenna
- 802.11a/n/ac dual chain wireless
- Gigabit Ethernet
- 716 MHz CPU, 256 MB RAM
- RouterOS level 3 license (CPE or Point-to-Point)



SEXTANT G

mt.lv/p/183 

An outdoor 5 GHz 802.11a/n high power wireless device with an 18 dBi integrated antenna and Gigabit Ethernet.

- 5 GHz 18 dBi antenna
- 802.11a/n high power dual chain wireless
- Gigabit Ethernet
- 600 MHz CPU, 64 MB RAM
- RouterOS level 3 license (CPE or Point-to-Point)



QRT 5

mt.lv/p/222 

An outdoor 5 GHz 802.11a/n high power wireless device for long distances with a 24 dBi integrated antenna and Gigabit Ethernet.

- 5 GHz 24 dBi antenna
- 802.11a/n high power dual chain wireless
- Gigabit Ethernet
- 600 MHz CPU, 64 MB RAM
- RouterOS level 4 license (AP, CPE or Point-to-Point)



QRT 5 ac

mt.lv/p/257 

An outdoor 5 GHz 802.11a/n/ac high power wireless device for long distances with a 24 dBi integrated antenna and Gigabit Ethernet.

- 5 GHz 24 dBi antenna
- 802.11a/n/ac high power dual chain wireless
- Gigabit Ethernet
- 720 MHz CPU, 128 MB RAM
- RouterOS level 4 license (AP, CPE or Point-to-Point)



DynaDish 5

mt.lv/p/256 

An outdoor 5 GHz 802.11a/n/ac high power wireless device for extra long distances with a 25 dBi integrated antenna and Gigabit Ethernet.

- 5 GHz 25 dBi antenna
- 802.11a/n/ac high power dual chain wireless
- Gigabit Ethernet
- 720 MHz CPU, 128 MB RAM
- RouterOS level 3 license (CPE or Point-to-Point)

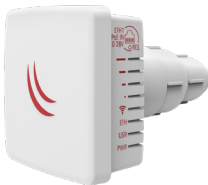

LDF 5

mt.lv/p/301 

A tiny 5 GHz system for super long distance links with a satellite offset dish antennas.

- 40 mm diameter to fit any available satellite TV dish with an offset mount
- Integrated 5 GHz 9 dBi antenna
- 802.11a/n dual chain wireless
- 10/100 Mbps Ethernet
- 600 MHz CPU, 64 MB RAM
- RouterOS level 3 license (CPE or Point-to-Point)

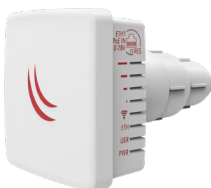

LDF 5 ac

mt.lv/p/338 

A tiny 5 GHz system with Gigabit Ethernet and 802.11a/n/ac support for super long distance links with satellite offset dish antennas

- 40 mm diameter to fit any available satellite TV dish with an offset mount
- Integrated 5 GHz 9 dBi antenna
- 802.11a/n/ac dual chain wireless
- Gigabit Ethernet
- 716 MHz CPU, 256 MB RAM
- RouterOS level 3 license (CPE or Point-to-Point)

SXT SA5

mt.lv/p/195 



An outdoor 5 GHz 802.11a/n high power wireless integrated base station with a 14 dBi 90° sector antenna.

- 5 GHz 14 dBi 90° sector antenna
- 802.11a/n dual chain high power wireless
- Gigabit Ethernet
- 600 MHz CPU, 64 MB RAM
- USB
- RouterOS level 4 license (AP, CPE or Point-to-Point)

SXT SA5 ac

mt.lv/p/233 



An outdoor 5 GHz 802.11a/n/ac high power wireless integrated base station with a 14 dBi 90° sector antenna.

- 5 GHz 14 dBi 90° sector antenna
- 802.11a/n/ac dual chain high power wireless
- Gigabit Ethernet
- 720 MHz CPU, 128 MB RAM
- USB
- RouterOS level 4 license (AP, CPE or Point-to-Point)

mANTBox 52 15s

mt.lv/p/522 



A dual-band 2.4/5 GHz base station with a powerful built-in sector antenna, PoE support, Gigabit Ethernet and SFP. One powerful package for all your outdoor network needs, perfect for camps, stadiums and parks!

- Strong dual-chain dual-band 2.4/5 GHz wireless
- Gigabit Ethernet & SFP for fiber connectivity
- Powerful built-in dual polarization antenna
- Quad-core CPU
- 802.3af/at PoE-in
- Reach distance up to 20 km
- IPsec hardware offloading

mANTBox 15s

mt.lv/p/279 



An outdoor 5 GHz 802.11a/n/ac high power wireless integrated base station with a 15 dBi 120° sector antenna and an SFP port.

- 5 GHz 15 dBi 120° sector antenna
- 802.11a/n/ac dual chain high power wireless
- Gigabit Ethernet
- 720 MHz CPU, 128 MB RAM
- SFP port for 1.25 Gigabit connectivity



mANTBox 19s

mt.lv/p/280 

An outdoor 5 GHz 802.11a/n/ac high power wireless integrated base station with a long range 19 dBi 120° sector antenna and an SFP port.

- 5 GHz 19 dBi 120° sector antenna
- 802.11a/n/ac dual chain high power wireless
- Gigabit Ethernet
- 720 MHz CPU, 128 MB RAM
- SFP port for 1.25 Gigabit connectivity



OmniTik 5

mt.lv/p/117 

An outdoor 5 GHz 802.11a/n high power wireless integrated access point with two integrated 7.5 dBi omni antennas and 5 Ethernet ports.

- 2 integrated 5 GHz 7.5 dBi omni antennas
- 802.11a/n dual chain high power wireless
- 5x 10/100 Mbps Ethernet ports
- 600 MHz CPU, 64 MB RAM
- USB



OmniTik 5 ac

mt.lv/p/302 

An outdoor 5 GHz 802.11a/n/ac high power wireless integrated access point with two integrated 7.5 dBi omni antennas and five Ethernet ports.

- 2 integrated 5 GHz 7.5 dBi omni antennas
- 802.11a/n/ac dual chain high power wireless
- 5 Gigabit Ethernet ports
- 720 MHz CPU, 128 MB RAM
- USB



OmniTik 5 PoE

mt.lv/p/133 

An outdoor 5 GHz 802.11a/n high power wireless integrated access point with two integrated 7.5 dBi omni antennas and 5 Ethernet ports with PoE output.

- 2 integrated 5 GHz 7.5 dBi omni antennas
- 802.11a/n dual chain high power wireless
- 5x 10/100 Mbps Ethernet ports (PoE output on ports 2-5)
- 600 MHz CPU, 64 MB RAM
- USB
- RouterOS level 4 license (AP, CPE or Point-to-Point)



OmniTik 5 PoE ac

mt.lv/p/303 

An outdoor 5 GHz 802.11a/n/ac high power wireless integrated access point with two integrated 7.5 dBi omni antennas and 5 Ethernet ports with PoE output.

- 2 integrated 5 GHz 7.5 dBi omni antennas
- 802.11a/n/ac dual chain high power wireless
- 5 Gigabit Ethernet (PoE output on ports 2-5)
- 720 MHz CPU, 128 MB RAM
- USB
- RouterOS level 4 license (AP, CPE or Point-to-Point)



Groove 52

mt.lv/p/186 

Our smallest outdoor integrated wireless device with a selectable wireless band (2.4 GHz or 5 GHz) and N-male connector for an external antenna.

- 5 GHz 802.11a/n or 2.4 GHz 802.11b/g/n single chain wireless (selectable)
- N-male connector for external antenna
- 10/100 Mbps Ethernet
- 600 MHz CPU, 64 MB RAM
- RouterOS level 3 license (CPE or Point-to-Point)



GrooveA 52

mt.lv/p/187 

Our smallest outdoor integrated wireless AP with a selectable wireless band (2.4 GHz or 5 GHz) and N-male connector for external antenna.

- 5 GHz 802.11a/n or 2.4 GHz 802.11b/g/n single chain wireless (selectable)
- 2.4/5 GHz omni directional antenna (6 dBi 2.4 GHz, 8 dBi 5 GHz) included
- 10/100 Mbps Ethernet
- 600 MHz CPU, 64 MB RAM
- RouterOS level 4 license (AP, CPE or Point-to-Point)



GrooveA 52 ac

mt.lv/p/293 

Our smallest outdoor integrated wireless AP with a selectable wireless band (2.4 GHz or 5 GHz) and N-male connector for an external antenna.

- 5 GHz 802.11a/n or 2.4 GHz 802.11b/g/n single chain wireless (selectable)
- 2.4/5 GHz omni directional antenna (6 dBi 2.4 GHz, 8 dBi 5 GHz) included
- Gigabit Ethernet
- 720 MHz CPU, 64 MB RAM
- RouterOS level 4 license (AP, CPE or Point-to-Point)



Metal 52 ac

mt.lv/p/286 

A small size outdoor integrated super high power wireless AP in a weatherproof metal case with a selectable wireless band (2.4 GHz or 5 GHz) and N-male connector for an external antenna.

- 5 GHz 802.11a/n or 2.4 GHz 802.11b/g/n single chain wireless (selectable)
- 2.4/5 GHz omni directional antenna (6 dBi 2.4 GHz, 8 dBi 5 GHz) included
- Gigabit Ethernet
- 720 MHz CPU, 64 MB RAM
- RouterOS level 4 license (AP, CPE or Point-to-Point)



BaseBox 2

[mt.lv/p/205](#)

An outdoor 2.4 GHz 802.11b/g/n high power wireless integrated base station with two RPSMA connectors for external antennas and an expansion slot.

- 2.4 GHz 802.11b/g/n dual chain high power wireless
- 2x RPSMA connectors for external antennas
- 10/100 Mbps Ethernet
- 600 MHz CPU, 64 MB RAM
- miniPCIe slot, SIM slot, USB
- RouterOS level 4 license (AP, CPE or Point-to-Point)



BaseBox 5

[mt.lv/p/194](#)

An outdoor 5 GHz 802.11a/n high power wireless integrated base station with two RPSMA connectors for external antennas and an expansion slot.

- 5 GHz 802.11a/n dual chain high power wireless
- 2x RPSMA connectors for external antennas
- 10/100 Mbps Ethernet
- 600 MHz CPU, 64 MB RAM
- miniPCIe slot, SIM slot, USB
- RouterOS level 4 license (AP, CPE or Point-to-Point)



NetBox 5

[mt.lv/p/234](#)

An outdoor 5 GHz 802.11a/n/ac high power wireless integrated base station with two RPSMA connectors for external antennas.

- 802.11a/n/ac dual chain high power wireless
- 2 RPSMA connectors for external antennas
- Gigabit Ethernet
- 720 MHz CPU, 128 MB RAM
- RouterOS level 4 license (AP, CPE or Point-to-Point)



NetMetal 5 series

[mt.lv/p/237](#)

An rock solid, metallic outdoor 5 GHz 802.11a/n/ac high power wireless integrated base station with RPSMA connectors for external antennas. Extra slot for a cellular modem or a second wireless interface, to build a dual band AP.

- 802.11a/n/ac dual or triple chain super high power wireless
- 2-3 RPSMA connectors for external antennas
- Gigabit Ethernet
- SFP port for 1.25 Gigabit connectivity
- 720 MHz CPU, 128 MB RAM
- miniPCIe slot for additional interface (some models), USB port
- RouterOS level 4 license (AP, CPE or Point-to-Point)
- Weatherproof metal enclosure (IP66)



NetMetal ac²

[mt.lv/p/480](#)

Our toughest long-range AP, now with dual-band support

- 802.11 b/g/n 2.4 GHz dual-chain high power wireless
- 802.11 a/n/ac 5 GHz dual-chain high power wireless
- Gigabit Ethernet port
- 716 MHz quad-core CPU, 256 MB RAM
- Two RP-SMA connectors for extra antennas
- miniPCIe slot for additional interface, USB port
- SFP port for 1.25 Gigabit connectivity

Wireless Wire Dish

[mt.lv/p/353](#) 



2 Gb/s aggregate link up to 1500m+ without cables!

- Includes two LHGG 60 devices for 60 GHz link
- 1 Gbps full duplex AES encrypted
- Devices already paired together
- Distances 1,500 m+
- Outdoor weatherproof enclosures
- Four core 716 MHz CPU, 256 MB RAM

Wireless Wire

[mt.lv/p/331](#) 



2 Gb/s aggregate link up to 200m+ without cables!

- Includes two WAP60 devices for 60 GHz link
- 1 Gbps full duplex AES encrypted
- Devices already paired together
- Distances 200 m+
- Outdoor weatherproof enclosures
- Four core 716 MHz CPU, 256 MB RAM

wAP 60G AP

[mt.lv/p/345](#) 



Weatherproof integrated 60 GHz wireless unit to be used indoors or outdoors as a base station or a CPE.

- 60 GHz phase array 60° beamforming antenna
- 4 core 716 MHz CPU, 256 MB RAM
- Distances 200 m+
- Gigabit Ethernet
- Works through most windows, depending on their material
- Outdoor weatherproof enclosure
- RouterOS level 4 license (AP, CPE or Point-to-Point)

wAP 60G

[mt.lv/p/347](#) 



Weatherproof integrated 60 GHz wireless unit to be used indoors or outdoors as a Point-to-Point or a CPE.

- 60 GHz phase array 60° beamforming antenna
- 4 core 716 MHz CPU, 256 MB RAM
- Distances 200 m+
- Gigabit Ethernet
- Works through most windows, depending on their material
- Outdoor weatherproof enclosure
- RouterOS level 3 license (CPE or Point-to-Point)

wAP 60Gx3 AP

mt.lv/p/448 



The wAP 60Gx3 AP is a new access point model for the 60 GHz spectrum. Compared with the regular wAP 60G AP, this new model has a completely new antenna array, with support for a much wider angle of coverage and is optimized specifically for multipoint operation.

The 96 antenna elements work with beamforming technology to provide connectivity for up to eight 60 GHz client devices at the same time, in a 180 degree field of view. Build a cost effective point to multipoint setup in the clean 60 GHz wireless spectrum, at a fraction of the cost.

Two units can be used in point-to-point configurations as well.

- Quad-core 716 MHz CPU, 256 MB RAM
- Gigabit Ethernet
- Integrated Phase array 180° beamforming

Cube 60G ac

mt.lv/p/530 



A high-speed 60 GHz CPE with Gigabit Ethernet and a 5 GHz failover. The easy and affordable way of eliminating interference and downtime!

- Reach distance up to 800m
- 60 GHz with an automatic 5 GHz backup connection
- Gigabit Ethernet with PoE-in
- Powerful quad-core CPU
- Compact and durable

Cube Lite60

mt.lv/p/478 



The most affordable 60 GHz CPE for crowded wireless spectrum

- 10/100 Mbit Ethernet
- Built-in 60 GHz 802.11ad wireless
- Passive PoE
- Distances up to 800 m

Wireless Wire Cube

mt.lv/p/529 



A 2 Gb/s 60 GHz aggregate link with a 5 GHz failover. Forget about wires or downtime! Best price/performance on the market, stealthy and sturdy design.

- Reach distance up to 800m
- 60 GHz with an automatic 5 GHz backup connection
- Gigabit Ethernet with PoE-in
- Powerful quad-core CPU
- Includes two Cube 60G ac devices that are already paired together

Wireless Wire nRAY

mt.lv/p/518 



The most compact wireless 2 Gb/s aggregate link in the 1500 m range or more! Improved snow-resistant design is perfect for harsh weather environments. Cables can no longer limit you!

- Reach distance in the 1500 m range or more
- Preconfigured to connect automatically
- Secure AES encrypted 60 GHz connection
- Gigabit Ethernet
- PoE injectors included

6 GHz integrated units

SXT 6

mt.lv/p/310 



The SXT 6 is an outdoor wireless device for licensed bands with a dual chain 16 dBi 28° 5.9-6.4 GHz integrated antenna.

- 5.9-6.4 GHz 16 dBi antenna for licensed bands
- 802.11a/n dual chain wireless
- Gigabit Ethernet
- 600 MHz CPU, 64 MB RAM
- RouterOS level 4 license (AP, CPE or Point-to-Point)

BaseBox 6

mt.lv/p/421 



An outdoor wireless device, fitted with two SMA connectors for antennas, and a cable hood for protection against moisture.

- 5.9-6.4 GHz frequency range
- 802.11a/n dual chain wireless
- Gigabit Ethernet and 2 RP-SMA connectors for antennas
- 600 MHz CPU, 64 MB RAM
- RouterOS level 4 license (AP, CPE or Point-to-Point)

DynaDish 6

mt.lv/p/323 



The DynaDish 6 is an outdoor wireless device for licensed bands with a dual chain 25 dBi 5.9-6.4 GHz integrated antenna.

- 5.9-6.4 GHz 25 dBi antenna for licensed bands
- 802.11a/n dual chain wireless
- Gigabit Ethernet
- 600 MHz CPU, 64 MB RAM
- RouterOS level 4 license (AP, CPE or Point-to-Point)



hAP mini

mt.lv/p/311 

A tiny size 2.4 GHz SOHO AP with three Ethernet ports in a tower case.

- 802.11b/g/n dual chain wireless
- 3x 10/100 Mbps Ethernet ports
- 650 MHz CPU, 32 MB RAM
- Tiny size (8 cm tall) tower enclosure
- Most affordable MikroTik AP



hAP lite TC

mt.lv/p/265 

A compact 2.4 GHz SOHO AP with four Ethernet ports in a colorful tower case.

- 802.11b/g/n dual chain wireless
- 4x 10/100 Mbps Ethernet ports
- 650 MHz CPU, 32 MB RAM
- Compact colorful tower case
- Button triggered WPS



hAP lite classic

mt.lv/p/253 

A compact 2.4 GHz SOHO AP with four Ethernet ports in a desktop case.

- 802.11b/g/n dual chain wireless
- 4x 10/100 Mbps Ethernet ports
- 650 MHz CPU, 32 MB RAM
- Compact desktop case
- Button triggered WPS



hAP

mt.lv/p/260 

A compact 2.4 GHz SOHO AP with five Ethernet ports in a desktop case and PoE support.

- 802.11b/g/n dual chain wireless
- 5x 10/100 Mbps Ethernet ports (PoE output on port 5)
- 650 MHz CPU, 64 MB RAM
- Compact desktop case
- USB

mAP

mt.lv/p/240 



A small size travel router with 2.4 GHz wireless, two Ethernet ports and PoE output. Configure the ports as desired (one WAN and one LAN, or any other combination).

- 802.11b/g/n dual chain wireless
- 2x 10/100 Mbps Ethernet ports (PoE output on port 2)
- 650 MHz CPU, 64 MB RAM
- Accepts power from a wide variety of sources - USB, PoE and power jack
- Small case

cAP life

mt.lv/p/307 



A tiny 2.4 GHz AP, perfect for public locations and hospitality businesses.

- Two different casings included – ceiling and wall mount
- 802.11b/g/n dual chain wireless
- 1.5 dBi 2.4 GHz antenna
- 10/100 Mbps Ethernet
- 650 MHz CPU, 64 MB RAM

cAP

mt.lv/p/245 



A Compact 2.4 GHz AP with ceiling case for larger coverage, perfect for public locations and hospitality businesses.

- 802.11b/g/n dual chain wireless
- 2 dBi 2.4 GHz antenna
- 10/100 Mbps Ethernet
- 650 MHz CPU, 64 MB RAM
- Ceiling case

wAP

mt.lv/p/264 



A small weatherproof 2.4 GHz wireless access point for mounting on a ceiling, wall or pole.

- 802.11b/g/n dual chain wireless
- 10/100 Mbps Ethernet
- 650 MHz CPU, 64 MB RAM
- Weatherproof outdoor case, available in white and black



RB951Ui-2HnD

mt.lv/p/190 

A high power 2.4 GHz AP in desktop case with five Ethernet ports and PoE support.

- 802.11b/g/n 2.4 GHz high power dual chain wireless
- 5x 10/100 Mbps Ethernet ports (PoE output on port 5)
- 600 MHz CPU, 128 MB RAM
- Compact desktop case
- USB, NAND memory for storage



RB951G-2HnD

mt.lv/p/172 

A high power 2.4 GHz AP in desktop case with five Gigabit Ethernet ports.

- 802.11b/g/n 2.4 GHz high power dual chain wireless
- 5 Gigabit Ethernet ports
- 600 MHz CPU, 128 MB RAM
- Compact desktop case
- USB, NAND memory for storage



RB2011UiAS-2HnD-IN

mt.lv/p/158 

A high power multi port 2.4 GHz AP in a metal desktop case with PoE functionality and support for optical fiber connectivity.

- 802.11b/g/n 2.4 GHz high power dual chain wireless with external dipole antennas
- 5x Gigabit Ethernet ports
- 5x 10/100 Mbps Ethernet ports
- Ethernet port 10 can power other PoE capable devices
- SFP port for 1.25 Gigabit connectivity
- 600 MHz CPU, 128 MB RAM, LCD display and USB
- Sturdy metal desktop enclosure



mAP lite

mt.lv/p/283 

A tiny size travel router with 2.4 GHz AP functionality.

- Our smallest wireless access point, barely larger than a matchbox
- 802.11b/g/n dual chain wireless
- 10/100 Mbps Ethernet
- Can be used as a client device to improve laptop signal range
- 650 MHz CPU, 64 MB RAM



hAP ac lite

mt.lv/p/278

A compact dual concurrent 2.4 GHz / 5 GHz SOHO AP with five Ethernet ports in a desktop case and PoE support

- 802.11b/g/n dual chain and 802.11a/n/ac single chain wireless
- Five 10/100 Mbps Ethernet ports (PoE output on port 5)
- 650 MHz CPU, 64 MB RAM
- Compact classic desktop case
- USB



hAP ac lite tower

mt.lv/p/299

A compact dual concurrent 2.4 GHz / 5 GHz SOHO AP with five Ethernet ports in a universal case and PoE support.

- 802.11b/g/n dual chain and 802.11a/n/ac single chain wireless
- Five 10/100 Mbps Ethernet ports (PoE output on port 5)
- 650 MHz CPU, 64 MB RAM
- Universal case to be positioned either horizontally or vertically
- USB



hAP ac

mt.lv/p/284

A dual concurrent 2.4 GHz / 5 GHz high power AP with five Gigabit Ethernet ports, SFP and PoE support.

- 802.11b/g/n triple chain and 802.11a/n/ac triple chain high power wireless
- 5 Gigabit Ethernet ports (PoE output on port 5)
- SFP port for 1.25 Gigabit connectivity, USB
- 720 MHz CPU, 128 MB RAM



wsAP ac lite

mt.lv/p/350

An in-wall dual concurrent 2.4 GHz / 5 GHz wireless access point with three Ethernet ports and telephone jack pass through for hospitality networks.

- In-wall case that fits US and EU most popular telecommunication sockets
- 802.11b/g/n 2.4 GHz dual chain and 802.11a/n/ac 5 GHz single chain wireless
- Pass through telephone jack (RJ11)
- USB for charging mobile devices or for storage
- 650 MHz CPU, 64 MB RAM

hAP ac²

mt.lv/p/344 

The hAP ac² is a Dual-concurrent Access Point, that provides Wifi coverage for 2.4 GHz and 5 GHz frequencies at the same time. Five 10/100/1000 Ethernet ports provide Gigabit connections for your wired devices, and USB can be used for external storage or 4G/LTE modem.

New design universal case allows unit to be positioned either horizontally (desktop) or vertically (tower case). Wall anchored mounting kit is provided.



- 802.11b/g/n dual chain high power wireless
- 802.11a/n/ac dual chain high power wireless
- 4 core 716 MHz CPU, 128 MB RAM
- New design universal case to be positioned either horizontally (desktop) or vertically (tower case)
- Support for IPsec hardware encryption and The Dude monitoring server
- USB

cAP ac

mt.lv/p/343 



A powerful dual concurrent 2.4 GHz / 5 GHz wireless access point with two Gigabit Ethernet ports and PoE functionality, that looks beautiful on both walls and ceilings.

- 802.11b/g/n dual chain wireless
- 802.11a/n/ac dual chain wireless
- 2 Gigabit Ethernet ports (PoE output on port 2)
- 716 MHz CPU, 128 MB RAM
- The customizable mode button in the device center will turn off all lights and sounds, can be reconfigured to launch any RouterOS script.
- Two different casings included – circular and square, to match any taste.

RB4011iGS+5HacQ2HnD-IN

mt.lv/p/423 



The RB4011 uses the amazingly powerful quad core Cortex A15 chip from Annapurna labs, an Amazon company, same as in our carrier grade RB1100AHx4 unit.

- Quad-core 1.4 GHz CPU
- 1 GB of RAM
- Quad chain 5 GHz, dual chain 2 GHz access point
- All metal passive cooled enclosure
- External antennas for best coverage

A wireless dual-band router with Gigabit Ethernet ports and external high gain antennas for more coverage. The new enclosure allows mounting the device vertically or horizontally. A wall mount set is also included.

- 5 x Gigabit Ethernet ports
- iOS/Android app for quick and easy configuration
- USB
- PoE-in/PoE-out
- 128 MB NAND, 256 MB RAM
- Strong dual-chain dual-band 2.4/5 GHz wireless
- Powerful external high gain antennas (3 – 5.5 dBi). You can use the SMA ports to add antennas of your choice
- Powerful quad-core CPU



wAP ac - upgraded version

Black mt.lv/p/525 

White mt.lv/p/524 

A new revision of the popular dual-band weatherproof wireless access point for mounting on a pole, wall, or the ceiling. This wAP ac features 2x Gigabit Ethernet ports, enhanced wireless antenna performance, more RAM, and a powerful quad-core CPU!

- Two Gigabit Ethernet ports
- PoE-in
- Better cooling
- Weatherproof outdoor case, available in white or black
- Can be fixed to any external wall from the inside of the case – for extra security and less visible attachments



The ceiling AP on steroids! Our bestseller cAP is back – juiced up and stronger than ever. Compared to the previous cAP models, the improved high-gain antenna increases the covered area by up to 100%!

- Gigabit Ethernet
- Improved dual-band 2.4/5 GHz signal
- PoE-in, PoE-out
- Inconspicuous and compact

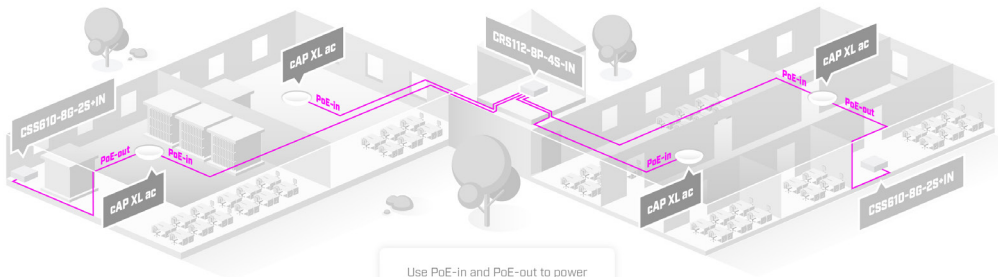

Use PoE-in and PoE-out to power cAP XL ac and other devices - like network switches!

Devices with LTE support

wAP ac LTE series

The wAP ac LTE is a small dual band weatherproof wireless access point with a built in cellular modem that supports 2G, 3G and 4G (LTE) connectivity. It has two Gigabit Ethernet ports, a powerful quad-core 716 MHz CPU and 128 MB of RAM. Dual-chain 2.4 GHz and dual-chain 5GHz wireless for dual concurrent AP coverage will solve most interference issues in a crowded environment.

Four versions are available:



- **wAP R ac** wAP R ac is shipped without an LTE card (there is an extra empty miniPCI-e slot), so you can use your own LTE card.
- **wAP ac LTE kit** includes LTE modem that supports International LTE bands 1,2,3,7,8,20,38 and 40.
- **wAP ac 4G kit** includes LTE modem that supports International/USA LTE bands FDD bands 3 (1800MHz), 7 (2600MHz), 20 (800MHz) and 31 (450MHz), as well as LTE TDD bands 41n (2500MHz), 42 (3500MHz) and 43 (3700MHz).
- **wAP ac LTE6 kit** includes the new R11e-LTE6 Category 6 modem, which enables carrier aggregation and allows the device to use multiple bands at the same time. It supports LTE FDD bands 1(2100)/2(1900)/3(1800)/5(850)/7(2600)/8 (900)/12(700)/17(700)/20(800)/25(1900)/26(850), as well as LTE TDD bands 38(2600)/39(1900)/40(2300)/41n(2500).

wAP LTE series

The wAP LTE is a small weatherproof wireless access point with a built in cellular modem that supports 2G, 3G and 4G (LTE) connectivity. Connect to the wAP's built-in 802.11b/g/n wireless and access the LTE network from your phone or any other wireless device. The wAP LTE also has one 10/100 Ethernet LAN port for your wired devices.

Four versions are available:



- **wAP LTE kit** includes LTE modem that supports International LTE bands 1,2,3,7,8,20,38 and 40.
- **wAP LTE kit-US** includes LTE modem that supports LTE bands 2,4,5 and 12, mostly used by mobile operators in United States, Canada and Latin America.
- **wAP R** is shipped with without LTE card installed (empty miniPCI-e slot), so you can use your own LTE card.

LtAP LTE series

LtAP is a compact, heavy-duty weatherproof wireless access point with three SIM slots and GNSS support (GPS, GLONASS, BeiDou, Galileo). It has high power 2.4 GHz 802.11b/g/n wireless and a Gigabit Ethernet port for your wired devices. There are several power options – DC jack, POE-in and automotive. The unit comes with a two miniPCIe slots, offering many expansion options.

Four versions are available:



- **LtAP** is shipped without an LTE card (there is an extra empty miniPCI-e slot), so you can use your own LTE card.
- **LtAP LTE kit** includes LTE modem that supports International LTE bands 1,2,3,7,8,20,38 and 40. One miniPCIe slot is already populated with the LTE modem.
- **LtAP 4G kit** includes LTE modem that supports International/USA LTE bands FDD bands 3 (1800MHz), 7 (2600MHz), 20 (800MHz) and 31 (450MHz), as well as LTE TDD bands 41n (2500MHz), 42 (3500MHz) and 43 (3700MHz). One miniPCIe slot is already populated with the LTE modem.
- **LtAP LTE6 kit** includes the new R11e-LTE6 Category 6 modem, which enables carrier aggregation and allows the device to use multiple bands at the same time. It supports LTE FDD bands 1(2100)/2(1900)/3(1800)/5(850)/7(2600)/8 (900)/12(700)/17(700)/20(800)/25(1900)/26(850), as well as LTE TDD bands 38(2600)/39(1900)/40(2300)/41n(2500). One miniPCIe slot is already populated with the LTE modem.

LtAP mini series

The LtAP mini LTE kit is a small weatherproof wireless access point with a built in cellular modem that supports 2G (international version only), 3G and 4G (LTE) connectivity. It is also available separately, without the modem, so you can use your own.

Four versions are available:



- **LtAP mini LTE kit** includes LTE modem that supports International LTE bands 1,2,3,7,8,20,38 and 40.
- **LtAP mini LTE kit-US** includes LTE modem that supports LTE bands 2,4,5 and 12, mostly used by mobile operators in United States, Canada and Latin America.
- **LtAP mini 4G kit** includes LTE modem that supports LTE FDD bands 3 (1800MHz), 7 (2600MHz), 20 (800MHz) and 31 (450MHz), as well as LTE TDD bands 41n (2500MHz), 42 (3500MHz) and 43 (3700MHz).
- **LtAP mini** is shipped with without LTE card installed (empty miniPCI-e slot), so you can use your own LTE card.

LHG LTE series

The LHG LTE kit is a device for remote locations that are within cellular network coverage. Mount it outdoors, on a pole, mast or any high enough structure, and connect even where cell phones can't. Due to it's large sized high gain antenna, the device is capable to connect to cell towers in extreme rural locations, giving you the ability to provide last mile internet access where nothing else is available. The unit is equipped with one Ethernet port, has a built in high quality Category 4 modem for speeds of up to 150 Mbit/s downlink and 50 Mbit/s uplink. There is also a new Category 6 version for higher speed and additional features, see the list below.

Five versions are available:



- **LHG LTE kit** includes LTE modem that supports International LTE bands 1, 2, 3, 7, 8, 20, 38 and 40.
- **LHG LTE kit-US** includes LTE modem that supports LTE bands 2, 4, 5 and 12, mostly used by mobile operators in United States, Canada and Latin America.
- **LHG 4G kit** includes LTE modem that supports LTE FDD bands 3 (1800MHz), 7 (2600MHz), 20 (800MHz) and 31 (450MHz), as well as LTE TDD bands 41n (2500MHz), 42 (3500MHz) and 43 (3700MHz).
- **LHG LTE6 kit** features the new R11e-LTE6 Category 6 modem, which enables carrier aggregation and allows the device to use multiple bands at the same time. It supports LTE FDD bands 1(2100)/2(1900)/3(1800)/5(850)/7(2600)/8 (900)/12(700)/17(700)/20(800)/25(1900)/ 26(850), as well as LTE TDD bands 38(2600)/39(1900)/40(2300)/41n(2500).
- **LHG R** is shipped without an LTE card (there is an extra empty miniPCI-e slot), so you can use your own LTE card.

Devices with one Ethernet port _____

The RouterBOARD PCB series of devices come without enclosures, allowing you to build custom solutions or use existing telecommunication boxes for installations. These devices are versatile and customizable for any situation.

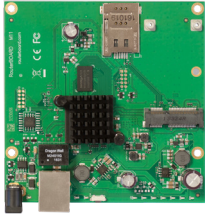

RBM11G

mt.lv/p/324 

The RBM11G is a fully featured RouterBOARD device perfect for using with your own enclosure or building a custom solution. It uses the same square PCB and mounting holes as its predecessors, you can simply swap out the older models with the brand new RBM11G.

- RB411 and RB911 form factor
- Powerful dual core 880 MHz CPU, 256 MB RAM
- Gigabit Ethernet port
- miniPCI slot, SIM slot
- Power jack

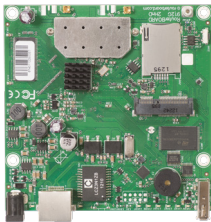

RB912UAG-2HPnD

mt.lv/p/191 

A small AP type OEM router with an integrated 2.4 GHz dual chain wireless, Gigabit Ethernet and expansion options.

- Small size
- 802.11b/g/n 2.4 GHz dual chain high power wireless onboard
- 600 MHz CPU, 64 MB RAM
- Gigabit Ethernet port
- miniPCI slot, SIM slots, USB
- Power jack
- RouterOS level 4 license (AP, CPE or Point-to-Point)

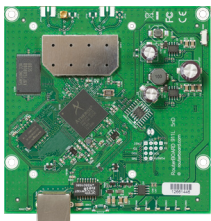

RB911-5Hn

mt.lv/p/223 

A small CPE type OEM router with an integrated 5 GHz single chain wireless.

- Low cost, small size
- 802.11a/n 5 GHz single chain wireless onboard
- 600 MHz CPU, 64 MB RAM
- 10/100 Mbps Ethernet
- RouterOS level 3 license (CPE or Point-to-Point)

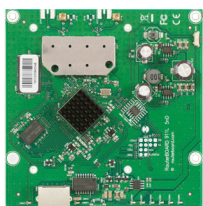

RB911-5HnD

mt.lv/p/225 

A small CPE type OEM router with an integrated 5 GHz dual chain wireless.

- Low cost, small size
- 802.11a/n 5 GHz dual chain wireless onboard
- 600 MHz CPU, 64 MB RAM
- 10/100 Mbps Ethernet
- RouterOS level 3 license (CPE or Point-to-Point)

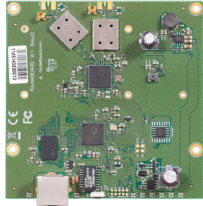

RB911-5HacD

mt.lv/p/287 

A small CPE type OEM router with an integrated 5 GHz 802.11a/n/ac dual chain wireless.

- Low cost, small size
- 802.11a/n/ac 5 GHz dual chain wireless onboard
- 650 MHz CPU, 64 MB RAM
- 10/100 Mbps Ethernet
- RouterOS level 3 license (CPE or Point-to-Point)

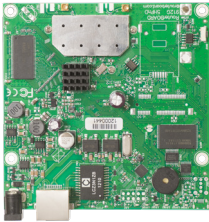

RB911G-5HPnD

mt.lv/p/182 

A small CPE type OEM router with an integrated 5 GHz dual chain wireless and Gigabit Ethernet.

- Low cost, small size
- 802.11a/n 5 GHz dual chain high power wireless onboard
- 600 MHz CPU, 32 MB RAM
- Gigabit Ethernet port
- Power jack
- RouterOS level 3 license (CPE or Point-to-Point)

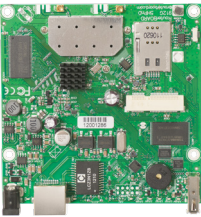

RB912UAG-5HPnD

mt.lv/p/184 

A small AP type OEM router with an integrated 5 GHz dual chain wireless, Gigabit Ethernet and expansion options.

- 802.11a/n 5 GHz dual chain high power wireless onboard
- 600 MHz CPU, 64 MB RAM
- Gigabit Ethernet port
- miniPCI, SIM slots, USB
- RouterOS L4 (AP, CPE or Point-to-Point)

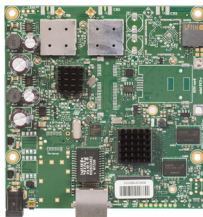

RB911G-5HPacD

mt.lv/p/241 

A small CPE type OEM router with an integrated 5 GHz 802.11a/n/ac dual chain wireless and Gigabit Ethernet.

- 802.11a/n/ac 5 GHz dual chain high power wireless onboard
- 720 MHz CPU, 128 MB RAM
- Gigabit Ethernet port
- Power jack
- RouterOS level 3 license (CPE or Point-to-Point)

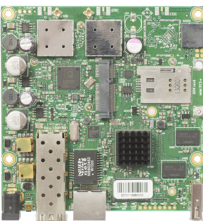

RB922UAGS-5HPacD

mt.lv/p/242 

A small, powerful AP type OEM router with an integrated 5 GHz 802.11a/n/ac dual chain wireless, Gigabit Ethernet, SFP and expansion options.

- 802.11a/n/ac 5 GHz dual chain high power wireless onboard
- 720 MHz CPU, 128 MB RAM
- One Gigabit Ethernet port
- SFP port for 1.25 Gigabit connectivity
- miniPCIe, SIM slots, USB
- RouterOS level 4 license (AP, CPE or Point-to-Point)



RB450Gx4

mt.lv/p/362 

The RB450Gx4 is powered by MikroTik RouterOS. It comes without an enclosure, you are free to use it in your own. The device form factor is identical to our previous RB850 and RB450 series, so you can even use the same enclosures.

- 4 core 716 MHz CPU, 1GB RAM
- microSD slot, two Power jacks, RS232 serial port
- Supports 10 V- 57 V input, 802.3af/at compliant
- Hardware IPsec encryption supported
- RouterOS level 5 license

RBM33G

mt.lv/p/334 

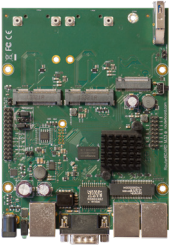

The RBM33G is a fully featured RouterBOARD device perfect for using in your own enclosure or building a custom solution. It uses the same PCB form factor and the same mounting holes as its predecessors (RB433 and RB953 series).

The RBM33G features a new MediaTek dual core CPU running at 880 MHz and 256 MB of DDR3 RAM and three Gigabit Ethernet ports. It is specially designed for setups that require two 3G/LTE modems.

- Powerful dual core 880 MHz CPU, 256 MB RAM
- 3 Gigabit Ethernet ports
- 2 miniPCIe slots, two SIM slots
- USB, microSD and a PCIe M.2 slot
- RouterOS level 4 license (AP, CPE or Point-to-Point)

Accessories

CA433U

mt.lv/p/61 



A medium size aluminium indoor case.

- Fits RBM33G, RB433, RB953 series
- Comes with changeable front panels
- 3 holes for N-female bulkhead connectors or swivel antennas and a hole for USB on the back
- High profile to accommodate high power wireless cards

CA150

mt.lv/p/59 



An indoor aluminium case for Ethernet RouterBOARDs.

- Fits RB450 and RB850 series
- Wall mounting holes on the back

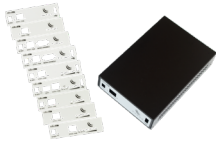

CA411-711

mt.lv/p/150 

A small aluminium indoor case.

- Fits RBM11G, RB411, RB911, RB912 and RB922 series
- Comes with changeable front panels
- High profile to accommodate high power wireless cards
- Wall mounting holes on the back

RB2011 mount

mt.lv/p/145 



The RB2011 wall mount kit for protecting the cables from unplugging.

- Ideal for public installations such as shared server rooms, attics, accessible closets and cabinets
- Fits all standard RB2011 desktop cases

RB4011 wall mount kit

mt.lv/p/438 



A simple solution for mounting the RB4011 in public locations to avoid unplugging of cables.

- Fits RB4011 series
- Made from durable steel
- Wall mounting holes on the back

Accessories for LTE



R11e-LTE6

mt.lv/p/473 

2G/3G/4G/LTE miniPCI-e card with carrier aggregation support (up to 300 Mbps) for bands 1/2/3/5/7/8/12/17/20/25/26/38/39/40/41n

- Two U.FL connectors
- Can be used with any MikroTik products with RouterOS and miniPCIe slot (except RB800 and RB4011)



R11e-LTE

mt.lv/p/341 

LTE miniPCI-e card for international bands.

- 2G/3G/4G/LTE miniPCI-e card
- Support for international LTE bands 1/2/3/5/7/8/20/38/40
- Two U.FL connectors
- Can be used with any MikroTik products with RouterOS and miniPCIe slot (except RB800)

ACSMAUFL

mt.lv/p/337 



U.FL-SMA female pigtail.

- To be used to connect an LTE card to an external antenna
- U.FL connector on one side, SMA female on other
- Designed for use with the wAP R

mANT LTE 5o

mt.lv/p/359 



An omnidirectional antenna specifically designed for LTE frequencies.

- Omnidirectional 360 degrees LTE antenna
- Signed for MikroTik LTE products
- Improve the connection in the areas with inadequate LTE service coverage
- 2 SMA female connectors
- 699 MHz- 2.7 GHz range

ACGPSA

mt.lv/p/354 



The active GPS antenna is the perfect companion for the LtAP mini, giving you the possibility to get accurate geographical coordinates of your router, even when it is mounted indoors.

The long cable allows to bring the antenna outside and mount it with the included magnet, or double sided tape.

- 1575.42 MHz center frequency
- 100% waterproof (IP67)
- SMA connector
- 26 dB gain

SMASMA

mt.lv/p/348 



SMA-Male to SMA Male cable.

- To be used to connect LTE card to an external antenna (via ACSMAUFL)
- 100 cm long, SMA-Male connectors on both sides
- Designed for use with the wAP R

DINrail PRO

mt.lv/p/434 



DINrail PRO is a mounting bracket for LtAP mini series products, designed to fit standard 35 mm × 7.5 mm DIN rails. This bracket will allow to install LtAP mini next to the industrial control equipment like water meters etc., as well as in equipment racks. Mounting bracket is made from metal and comes with a metal ring.



Q+DA0001

mt.lv/p/426 

40 Gbps direct attach QSFP+ cable

- 1m long
- Flexible
- Minimum bend radius 35 mm



Q+85MP01D

mt.lv/p/425 

40 Gbps 850nm optical QSFP+ module

- 4 independent full-duplex channels
- Up to 10 Gbps per channel bandwidth and aggregate bandwidth of 40 Gbps
- Strong connection over 100 m on OM3 Multimode Fiber (MMF) and 150 m on OM4 MMF
- Built-in digital diagnostic functions, including optical power monitoring
- For use in MikroTik products with QSFP+ ports for 40 Gbps connectivity
- Compatible with non-MikroTik QSFP+ devices as well



Q+BC0003-S+

mt.lv/p/449 

40 Gbps QSFP+ breakout cable to 4x10G SFP+. An easy way to connect 40 Gbps devices without upgrading your whole setup.

- 3m long
- Flexible
- Minimum bend radius 35 mm
- integrated QSFP+ module and 4 SFP+ modules



S-85DLC05D

mt.lv/p/180 

1.25G SFP transceiver for up to 550 meter fiber connection.

- 850 nm Dual LC connector
- Multi mode
- Up to 550 meter fiber connection
- For use in MikroTik products with SFP ports for 1.25 Gigabit connectivity
- Compatible with non-MikroTik SFP devices as well



S-31DLC20D

mt.lv/p/181 

1.25G SFP transceiver for up to 20 km fiber connection.

- 1310 nm Dual LC connector
- Single Mode
- Up to 20 km fiber connection
- For use in MikroTik products with SFP ports for 1.25 Gigabit connectivity
- Compatible with non-MikroTik SFP devices as well

S-3553LC20D

mt.lv/p/179 



A pair of 1.25G SFP transceivers for up to 20 km fiber connection on a single optical cable.

- 1.25G single mode optical SFP module with a LC connector, T1310 nm/R1550 nm
- 1.25G single mode optical SFP transceiver with an LC connector, T1550 nm/R1310 nm
- Up to 20 km fiber connection
- For use in MikroTik products with SFP ports for 1.25 Gigabit connectivity
- Compatible with non-MikroTik SFP devices as well

S-4554LC80D

mt.lv/p/420 



- Pair of 1.25G Single Mode optical SFP modules with a LC connector
- Supports any MikroTik device that has SFP or SFP+ ports
- Well suited for distances up to 80 km.

S+85DLC03D

mt.lv/p/198 



10G SFP+ transceiver for up to 300 meter 10 Gbps fiber connection.

- 850 nm Dual LC connector
- Multi mode
- Up to 300 meter 10 Gbps fiber connection
- For use in MikroTik products with SFP+ ports
- Compatible with non-MikroTik SFP+ devices as well

S-55DLC80D

mt.lv/p/419 



- 1.25G Single Mode optical SFP module with a Dual LC connector
- Supports any MikroTik device that has SFP or SFP+ ports
- Well suited for distances up to 80 km

S-RJ01

mt.lv/p/228 



Converts SFP port for 1.25 Gbps connectivity in fully functional Gigabit Ethernet port.

- Compatible with most Gigabit SFP ports available on various networking devices
- Up to 1.25 Gbps bi-directional data links
- 100 m transmission over unshielded

S+RJ10

mt.lv/p/329 



Converts SFP+ port in fully functional 10 Gigabit Ethernet port.

- Supports any MikroTik device that has SFP+ ports
- Supports 10 Mbps, 100 Mbps, 1 Gbps, 2.5 Gbps, 5 Gbps, 10 Gbps data rates
- For distances up to 200 m



S+AO0005

mt.lv/p/446

This is highly cost-effective way to connect two SFP/SFP+ devices for very short distances, within racks and across adjacent racks.

- 5 m SFP+ direct attach active optical cable
- Works with all our products with SFP/SFP+ ports



XS+2733LCI5D

mt.lv/p/539

A kit of two combined 1.25G SFP, 10G SFP+ and 25G SFP28 modules.

- Contains two SFP+ modules
- Can be used as a pair to achieve operating data rate up to 25 Gbps for distances up to 15km on a single optical cable
- Bidirectional
- SFP / SFP+ / SFP28
- 1270nm + 1330nm



XS+DA0001

mt.lv/p/527

Direct attach cable that supports not only SFP 1G and SFP+ 10G, but also the 25G SFP28 standard!

- A highly cost-effective way to connect two SFP/SFP+/SFP28
- Perfect for short distances - within racks and across adjacent racks
- Low cost, low power and low latency interconnect solution for 25-Gigabit Ethernet, Fiber Channel and other industry standards
- 1 meter long
- Direct attached compliant
- Fully conforms to the SFP+ MSA specification



XS+DA0003

mt.lv/p/528

Direct attach cable that supports not only SFP 1G and SFP+ 10G, but also the 25G SFP28 standard!

- A highly cost-effective way to connect two SFP/SFP+/SFP28
- Low cost, low power and low latency interconnect solution for 25-Gigabit Ethernet, Fiber Channel and other industry standards
- 3 meters long
- Direct attached compliant
- Fully conforms to the SFP+ MSA specification



XS+3ILCI0D

mt.lv/p/532

A combined 1.25G SFP, 10G SFP+ and 25G SFP28 module.

- A direct upgrade of our previous 10G SFP+ 10 km module: more functionality for the same price
- Added 25G SFP28 support – you can use one module in all your setups
- Perfect for the CCR2004-1G-12S+2XS connectivity router and any other multiport devices

CWDM

The CWDM is a passive MUX/DEMUX unit, which allows to combine up to eight fiber links into one, to simplify and reduce the cost of long distance fiber installations.

At the other location, the combined line is split back up again, so that instead of eight long fiber lines, you would only need one. The Coarse Wavelength-Division Multiplexing (CWDM) technology offers a solution which will increase capacity of existing fiber infrastructure by enabling multiple channels/ wavelengths over the same fiber cabling and will reduce costs for a new fiber optic deployment.

Available separately is a 1U mounting bracket and a wide variety of CWDM fiber optics modules, depending on your requirements.



FTC

mt.lv/p/246 

Fiber to copper converter in weatherproof outdoor case.

- 12-57 V PoE input
- Supports 1.25G 1000Base-X fiber to 10/100/1000 Mbps copper



12POW150

[mt.lv/p/300](#)

Hot swap 12 V 150 W AC/DC power supply for CCR1072-1G-8S+.

- 12 V 150 W AC/DC
- Hot swappable, zero downtime



PW48V-12V150W

[mt.lv/p/326](#)

Hot swap-48 V DC telecom power supply for CCR1072-1G-8S+.

- 48 V DC
- Hot swappable, zero downtime



18POW

[mt.lv/p/81](#)

A spare power supply for most RouterBOARD models.

- 24 V 0.8 A DC jack power supply
- Fits hAP mini, hAP lite and mAP lite
- Available with EU, UK, AR, AU or US plug



24HPOW

[mt.lv/p/84](#)

A spare high power supply with plug.

- 24 V 2.5 A stand alone power supply
- Recommended for RouterBOARD models with high power consumption (e.g. models with PoE output or for long cable runs with several high power wireless cards)
- Available with EU, UK or US plug



48POW

[mt.lv/p/85](#)

A spare high power supply with plug.

- 48 V 1.46 A 70 W stand alone power supply
- Recommended for RouterBOARD models with 48 V support (like RB800)
- Recommended for powering 48 V devices (IP cameras etc.) through PoE output of supported devices like CRS112-8P-4S-IN
- Available with EU, UK or US plug



MT48-480095-IIDG

mt.lv/p/504 

48 V, 0.95 A power supply for long Ethernet cable runs.

- Part of our GPEN concept
- Allows using long Ethernet cable runs and multiple GPER units



MT48-570080-IIDG

mt.lv/p/505 

57 V, 0.8 A power supply for long Ethernet cable runs.

- Part of our GPEN concept
- Allows using long Ethernet cable runs and multiple GPER units



GESP+PoE-IN

mt.lv/p/542 

A passive PoE injector with surge protection. Combine it with the GESP devices for maximum security and peace of mind.



GESP (upgraded revision)

mt.lv/p/452 

New revision of the Gigabit Ethernet Surge Protector in a waterproof enclosure. It can make all the difference when it comes to lightning strikes or static build-up.

- Can absorb multiple impacts
- Sealed inside a new and improved IP67 weatherproof enclosure
- Comes with a grounding wire



GI040A-60WF

mt.lv/p/556 

Hot swap power supply for the CCR2004-16G-2S+ – so you can replace the power supply without having to turn off or even restart the router. Zero downtime! CCR2004-16G-2S+ comes with two hot swap dual redundant power supplies. If one of them goes out of order at some point, the other one will take over. Then you can use this kit to replace the old power supply – and you don't even have to restart the router!



48V2A96W

mt.lv/p/358 

Spare 48 V power supply with plug for resource-hungry PoE-out devices.

- 48 V 2 A 96 W power supply
- Recommended for powering 48 V devices (IP cameras etc.) through PoE output of supported devices like CRS112-8P-4S-IN
- Providing 30% more current than the old model 48POW, more power per port
- Available with EU, UK or US plug



RBPOE

mt.lv/p/86

Low-cost passive PoE base unit for powering passive PoE devices over Ethernet.

- Helps reducing number of wires that lead up the tower
- Support 10-28 V PoE powering
- Input needs to be at least 18 V to accommodate any losses in cables



RBGPOE

mt.lv/p/100

Passive Gigabit PoE base unit for powering passive PoE devices over Ethernet.

- Helps reducing number of wires that lead up the tower
- For using with any RouterBOARD that supports 9-48 V PoE
- Shielded connectors

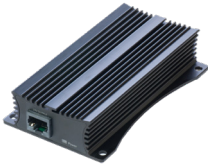

RBGPOE-CON-HP

mt.lv/p/141

48 to 24 V Gigabit PoE Converter.

- Allows to use any 48 V PoE source (including Passive PoE, telecom PoE, 802.3af and 802.3at) to power RouterBOARD devices
- Supports any 8-30 V capable RouterBOARD devices and 10/100/1000 Mbps Ethernet
- Capable to provide high power output - up to 24 W (up to 1 A at 24 V)
- Integrated heatsink; has mounting holes for attaching to a wall



MTP250-53V47-OD & MTP250-26V94-OD

mt.lv/p/546

mt.lv/p/547

Outdoor AC/DC power supply units for the MikroTik netPower product line. MTP250-53V47-OD can output 53V, while the MTP250-26V94-OD works with a 26V output. Both power supplies come in a sturdy IP67 enclosure with extra protection from dust and moisture.

Antennas and antenna accessories



mANT 15s

mt.lv/p/269

5 GHz 15 dBi 120° sector antenna with two RP-SMA connectors.

- Perfect companion for the BaseBox, NetBox, NetMetal or any other outdoor wireless device with RPSMA connectors
- 5.17 - 5.825 GHz 15 dBi 120° sector
- 2 RP-SMA connectors
- quickMOUNT pro included



mANT 19s

mt.lv/p/270 

5 GHz 19 dBi 120° sector antenna with two RP-SMA connectors for larger coverage.

- Perfect companion for the BaseBox, NetBox, NetMetal or any other outdoor wireless device with RPSMA connectors
- 5.17- 5.825 GHz 19 dBi 120° sector
- 2 RP-SMA connectors
- Metallic U bolt type mount included



mANT30

mt.lv/p/226 

30 dBi parabolic dish antenna for 5 GHz.

- Professional class 4.7-5.875 GHz 30 dBi dish antenna
- Designed for BaseBox, NetBox and NetMetal
- Can be used for any pole mounted wireless device
- 2 RP-SMA Female connectors
- 2 FlexGuide cables included
- Recommended to use with quickMOUNT extra



mANT30 PA

mt.lv/p/227 

30 dBi parabolic dish antenna with precision alignment mount for 5 GHz.

- Professional class 4.7-5.875 GHz 30 dBi dish antenna
- Designed for BaseBox, NetBox and NetMetal
- Can be used for any pole mounted wireless device
- 2 RP-SMA Female connectors
- 2 FlexGuide cables included
- Comes with a precision alignment mount



Radome Cover Kit for mANT30

mt.lv/p/247 

Cover kit for mANT reduces wind load, increases antenna operational life.

- Protects reflector surfaces from harsh environment
- Protects the antenna feed from falling objects
- Sustains wide range of temperature and direct sunlight
- Compatible with mANT30 and mANT30 PA



Sleeve30

mt.lv/p/277 

Sleeve30 kit for mANT30

- Enhance point-to-point link performance by reducing noise
- Reduce impact on adjacent RF devices by removing the side radiation
- Reduces wind load
- Protects antenna reflector and feed from harsh environment
- Excellent RF signal transparency
- Compatible with mANT30 and mANT30 PA

quickMOUNT

mt.lv/p/259 

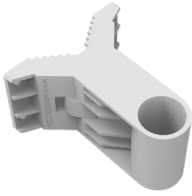

Basic wall mount adapter for small Point-to-Point and sector antennas (SXT, OmniTIK etc.)

- Simple and low cost
- To be mounted on the wall or use as an adapter from large diameter pole to small size antenna
- Gives possibility to turn antenna within 190°
- Possible to simultaneously mount two SXTs
- Supports any pole mountable device with weight less than 1.5 kg
- Very durable due to it's special composite material - anvilNITE (TM)

quickMOUNT extra

mt.lv/p/276 

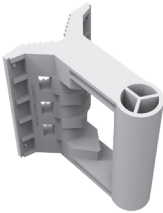

Basic wall mount adapter for large Point-to-Point and sector antenna.

- To be mounted on the wall or use as an adapter from large diameter pole to small size antenna
- Gives possibility to turn antenna within 190°
- Supports mANT, SXT, OmniTIK, BaseBox, DynaDish, mANT 30 etc.
- Recommended for long range heavy antennas with weight less than 8 kg
- Very durable due to it's special composite material - anvilNITE (TM)



nRayAIM-DH1

mt.lv/p/523 

nRayAIM-DH1 is an alignment and aiming attachment for the nRAY. Use it to attach a scope of your choice for even greater precision and easier installation of the Wireless Wire nRAY.

quickMOUNT pro

mt.lv/p/263 

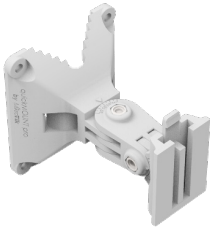

Advanced wall mount adapter for small Point-to-Point and sector antennas (SXT, OmniTIK, BaseBox etc.).

- To be mounted on the wall or use as an adapter from large diameter pole to small size antenna
- Gives possibility to turn antenna within 140° both in horizontal and vertical plane
- Possible to perfectly set antenna alignment using integrated graduated scale
- Supports any pole mountable device with weight less than 1.5 kg
- Very durable due to it's special composite material - anvilNITE (TM)

quickMOUNT pro LHG

mt.lv/p/294 



Advanced wall mount adapter for LHG.

- Advanced wall or pole mount adapter for our LHG antennas
- Gives possibility to turn antenna within 140° both in horizontal and vertical plane
- Possible to perfectly set antenna alignment using integrated graduated scale
- Very durable due to it's special composite material - anvilNITE (TM)



LHG mount

mt.lv/p/435 

The LHG mount is a basic pole mount adapter for LHG series products.

- Simple and low cost
- Supports all LHG series, products, including LHG XL
- Made from metal
- Package also includes a U-bolt and a K-58 mounting kit

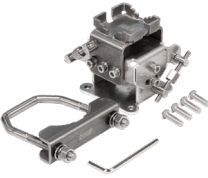

solidMOUNT

mt.lv/p/439 

Advanced pole mount adapter for LHG series products.

- Allows adjustment both vertically and horizontally
- Supports all LHG series, products, including LHG XL
- Made from metal
- Package also includes a U-bolt and a mounting kit



QM-X

mt.lv/p/281 

quickMOUNT-X – additional axis for pole-mounting SXTsq devices

- Enables vertical and horizontal adjustment on the pole
- Glass fiber reinforced nylon
- Lightweight, easy to use, extremely durable
- Maximum antenna weight- 2 kg
- Compatible with SXTsq series, DISC 5

Other accessories



RBMQS

mt.lv/p/456 

RBMQS- Mobile Quick Setup. A special tool that lets you manage MikroTik and other devices (including Ethernet-only!) from your smartphone over a Wi-Fi connection. Power it with a USB power bank and it will power your CPE over PoE.

- Portable assistant for CPE install, bandwidth test and configuration
- Can also be used as a temporary travel AP
- 10/100 Ethernet port
- 2.4 GHz 802.11b/g/n Wireless
- Passive PoE-in, 5- 30 V
- Passive PoE-out, 12 V 400 mA (when USB 5 V input is used)
- Max power consumption- 1 W



R11e-5HnD

mt.lv/p/204 

5 GHz 802.11a/n dual chain miniPCIe card with 2 MMCX connectors.

- 4920-5920 MHz 802.11a/n dual chain wireless
- 2 MMCX connectors
- Perfect for any RouterBOARD with a miniPCIe slot
- Output power up to 27 dBm



R11e-5HacD

mt.lv/p/243 

5 GHz 802.11a/n/ac dual chain miniPCIe card with 2 MMCX connectors.

- 4920-6100 MHz 802.11a/n/ac dual chain wireless
- Output power up to 27 dBm

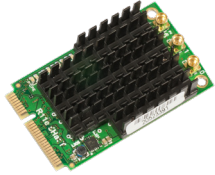

R11e-5HacT

mt.lv/p/273 

5 GHz 802.11a/n/ac triple chain miniPCIe card with 3 MMCX connectors for maximum bandwidth.

- 4920-6100 MHz 802.11a/n/ac triple chain wireless
- Perfect for any RouterBOARD with miniPCIe slot
- Up to 1.3 Gbps data rate and 80 MHz channels
- Output power up to 28 dBm



R11e-2HnD

mt.lv/p/209 

2.4 GHz 802.11b/g/n dual chain low profile miniPCIe card with 2 U.FL connectors.

- 2192-2732 MHz 802.11b/g/n dual chain wireless
- Perfect for any RouterBOARD with a miniPCIe slot
- Low profile, small heat-sink, designed for laptops
- Output power up to 29 dBm



R11e-2HPnD

mt.lv/p/208 

2.4 GHz 802.11b/g/n high power miniPCIe card with 2 MMCX connectors.

- 2192-2732 MHz 802.11b/g/n high power dual chain wireless
- Perfect for any RouterBOARD with a miniPCIe slot
- Output power up to 30 dBm

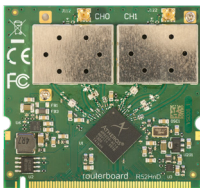

R52HnD

mt.lv/p/291 

2.4 GHz/5 GHz 802.11a/b/g/n high power miniPCI card with 2 MMCX connectors.

- 2192- 2732 MHz 802.11b/g/n high power dual chain wireless
- 4.920-6.100 GHz 802.11a/n high power dual chain wireless
- Output power up to 26 dBm



2.4GHz Dipole

mt.lv/p/213 

2.4 GHz dipole antenna with RPSMA connector. Attach two of those to the BaseBox 2 to have 2x2 MIMO 2.4 GHz access point.

- 2.4 GHz 5 dBi dipole antenna
- RPSMA connector
- Waterproof for outdoor use

HGO-antenna-OUT

mt.lv/p/481 

Outdoor antenna with RP-SMA Male.

- Dual-band 2.4GHz / 5 GHz
- Provides 3.3 dBi gain for the 2.4 GHz band and 5.5-7.1 dBi gain for the 5 GHz band

HGO-LTE-W

mt.lv/p/552 

A handy IoT combo antenna for both LTE and LoRa® frequencies. Perfect for the MikroTik KNOT LR series!

No need to buy several antennas for your Internet-of-things setups – just grab the new HGO-LTE-W antenna that can handle an impressive frequency spectrum: 699MHz – 3,8GHz.

That's right – you can use the same antenna for LTE, CAT-M/NB and LoRa® connectivity.

This antenna will transmit whichever signal your modem provides. For example, if you are using our KNOT LR8/LR9 kit, you can use this powerful 1.5 – 4 dBi antenna to communicate with all your 868 MHz devices and then send the data to the cloud via LTE.

Woobm

mt.lv/p/330 

The Wireless out of band management USB stick (Woobm-USB) is a useful assistant for any network administrator. Simply plug it into any RouterBOARD USB port and it will allow you to access the console of that device over wireless. It sets up as a wireless access point and has a simple web interface where you can access a fully featured terminal interface to configure your router, and where you can configure the Woobm itself.

It can even work as a wireless client: if you wish to manage many devices, just connect all the Woobms to one AP inside your server room and manage the routers through there.

- Supports 2.4 GHz 802.11b/g/n
- Antenna gain 1.5 dB
- Can work as a wireless client and AP at the same time
- Discovers neighbour RouterOS devices





ACMMCXRPSMA

[mt.lv/p/212](#)

Designed for adding second wireless interface to BaseBox, NetBox or NetMetal.

- MMCX to RPSMA pigtail
- 26 cm long, MMCX connector on one side, RPSMA to other
- Compatible with most of our miniPCI and miniPCIe wireless cards

Flex-guide

[mt.lv/p/210](#)



Ideally suited for our BaseBox, NetMetal and other products with RPSMA connectors.

- Low loss 50 cm RPSMA cable
- 50 cm long, RPSMA connectors on both sides
- For use with up to 6 GHz frequency
- Works with most antennas
- Suited for indoor and outdoor use
- Soldered, not crimped, for the best possible signal quality



RB5009 rackmount kit K-79

[mt.lv/p/544](#)

Kit for mounting RB5009 devices in 1U rackmounts.

Rack-holder SR-10U

[mt.lv/p/555](#)

A 19" 10U desktop rack with adjustable angle and additional space for cable management.

Mount it under the table or put it on the table – like we do it in our testing department. You can even attach a multi-plug extension cord to the back of this sturdy and lightweight aluminium rack.

Compatible with all MikroTik (and other vendor!) devices that would fit in a standard 19" rack. But there's more! With the small K-79 accessory kit, you can fit up to four RB5009UG+S+IN routers in a single 1U rackmount space or up to 40 routers in total!





To obtain MikroTik hardware and software, visit our distributors.
For more information and latest news go to mikrotik.com

